

Pay attention to this part.
There are two holes on both sides

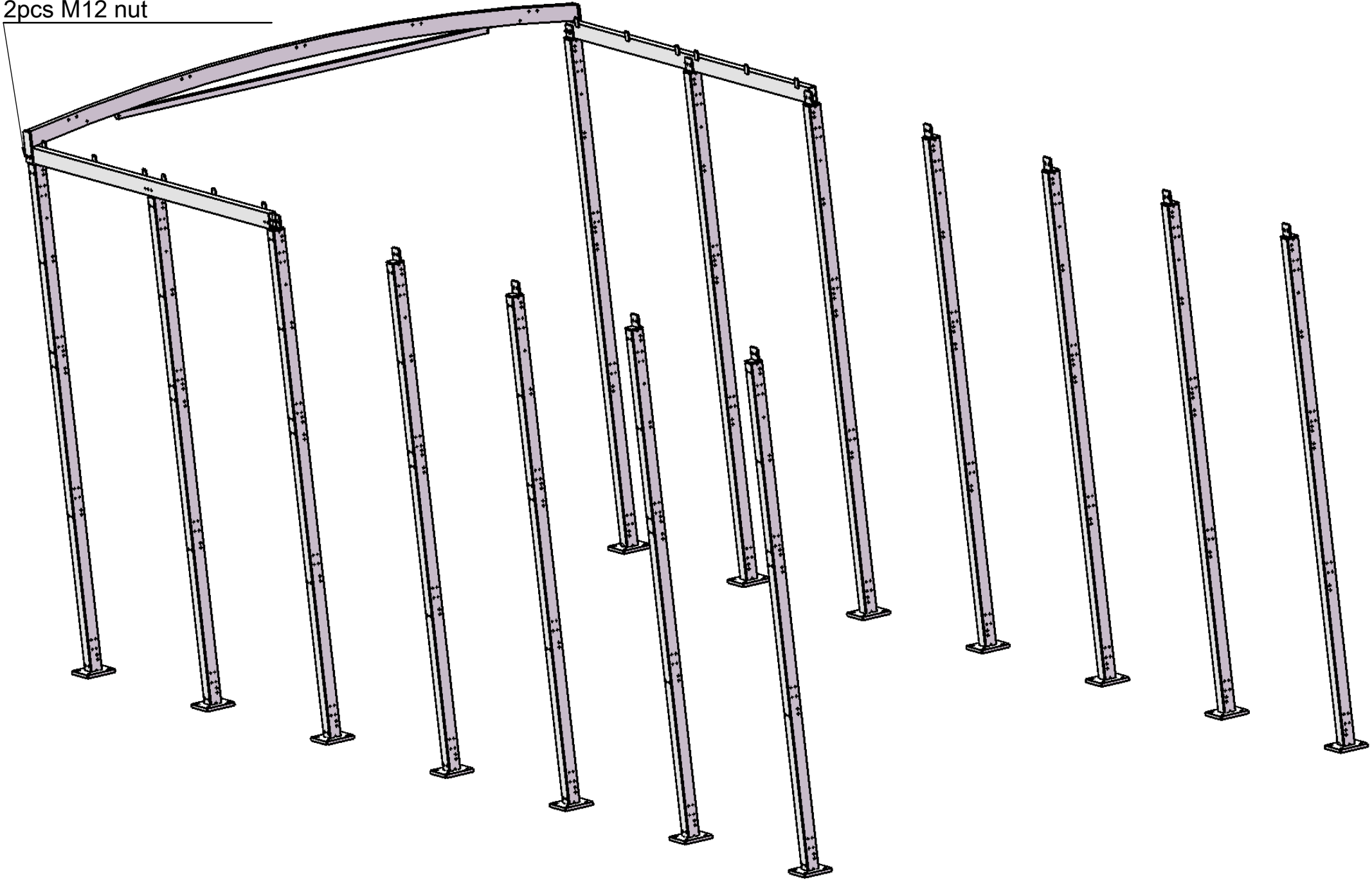

2pcs M12X90 bolt
4pcs M12 flat washer
2pcs M12 spring washer
2pcs M12 nut

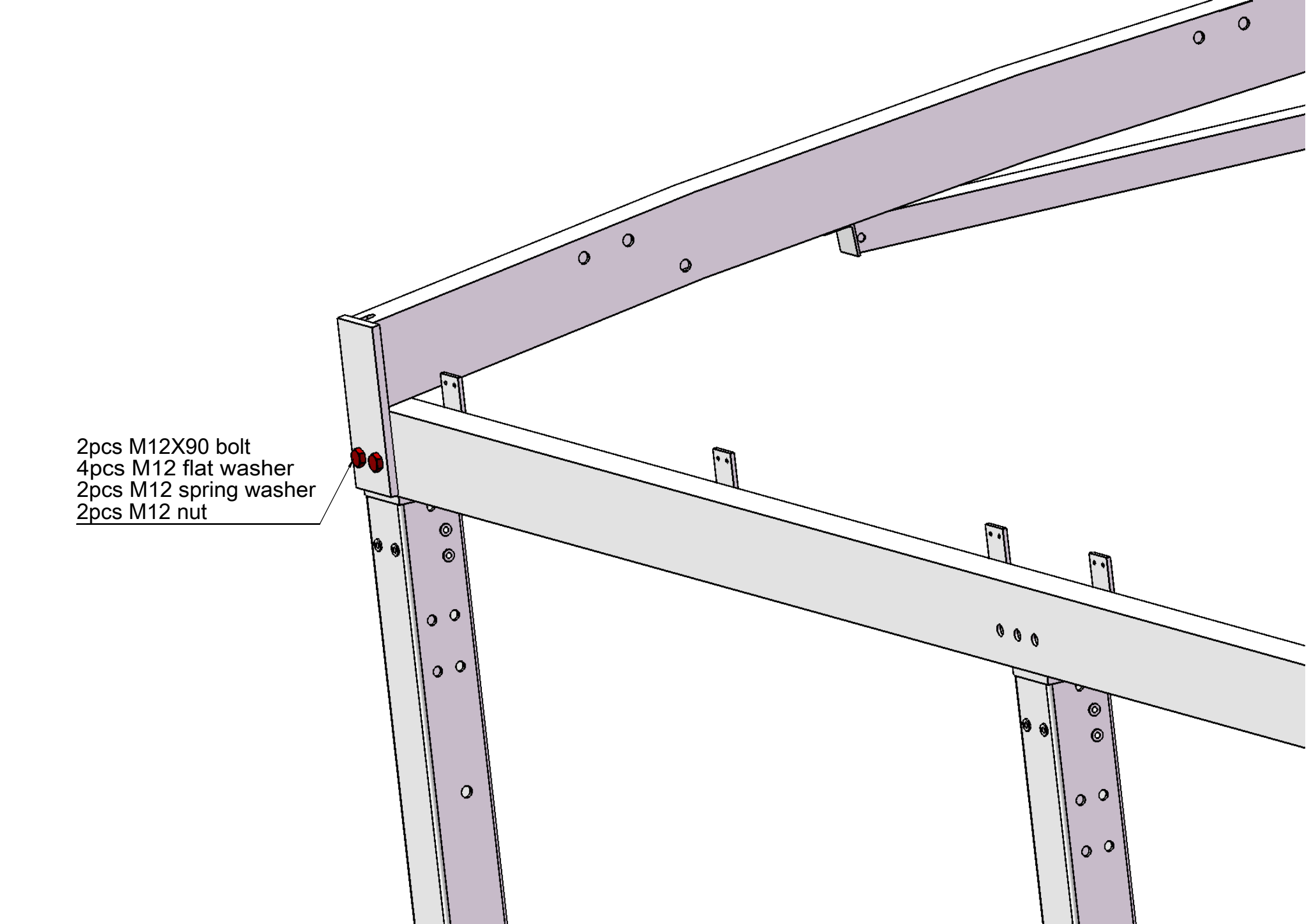



2pcs M12X90 bolt
4pcs M12 flat washer
2pcs M12 spring washer
2pcs M12 nut

The diagram illustrates a metal frame assembly. It features a vertical post on the left and a horizontal beam extending to the right. The post and beam are connected at their top ends. The post has a purple-colored section with several circular holes. The beam has a grey-colored section with several circular holes. A bolted joint is shown at the top of the post, where two red bolts are visible. The beam is supported by a vertical post on the right. The assembly is shown in a perspective view.

Pay attention to this part.
there is one hole on both sides

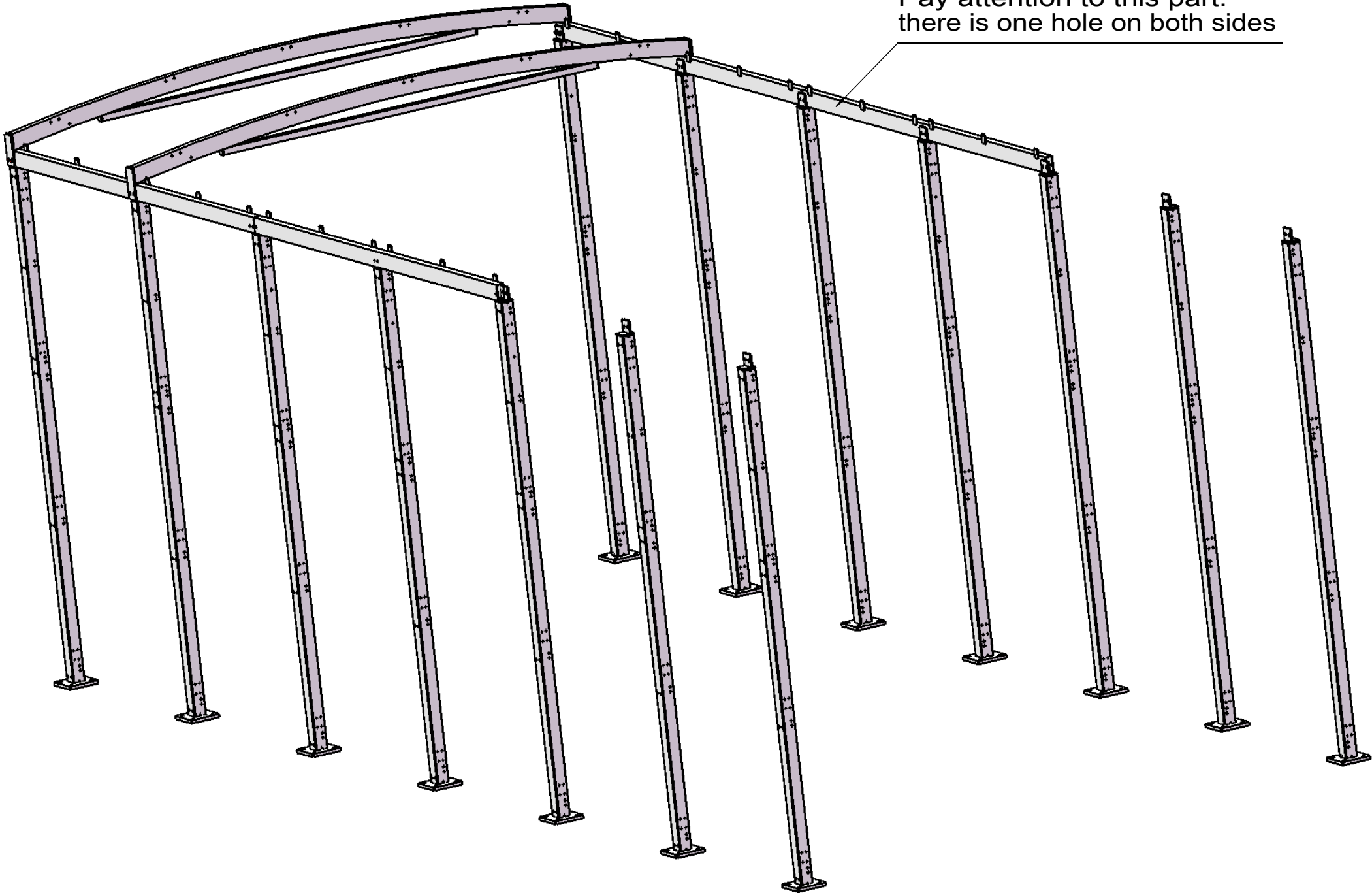

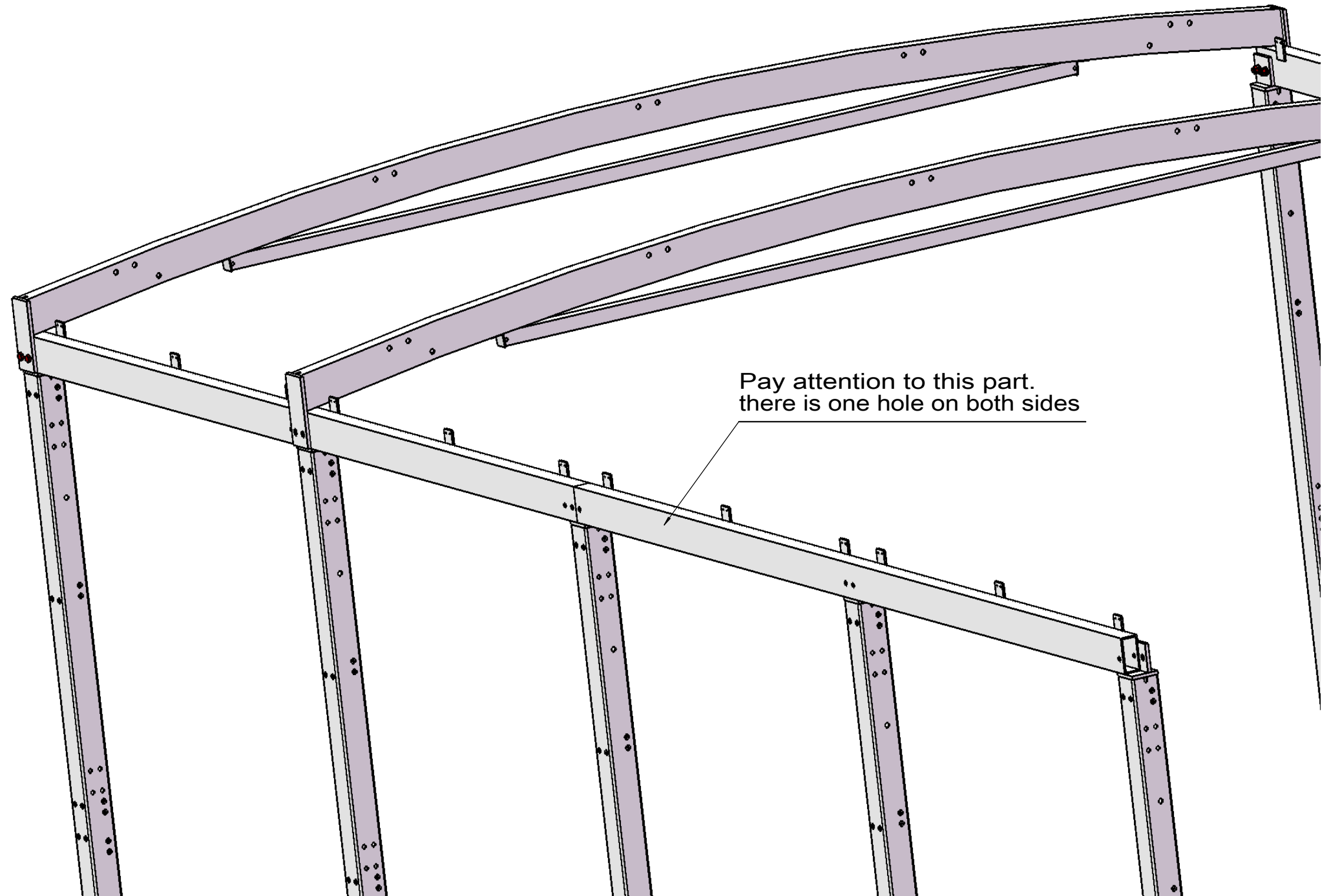

Pay attention to this part.
there is one hole on both sides

Use the below standards to fix
M12X90 bolt
M12 flat washer
M12 spring washer
M12 nut

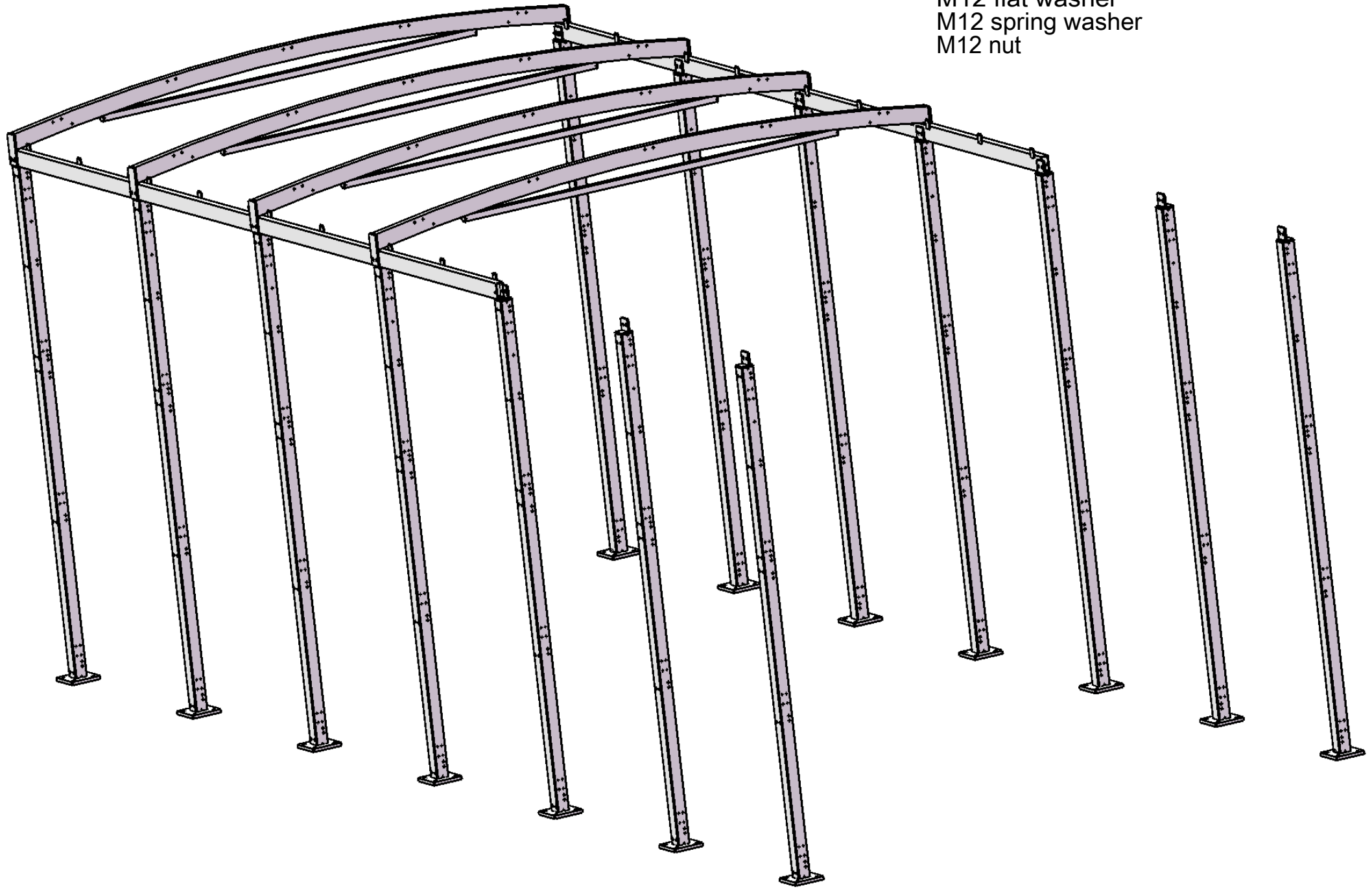

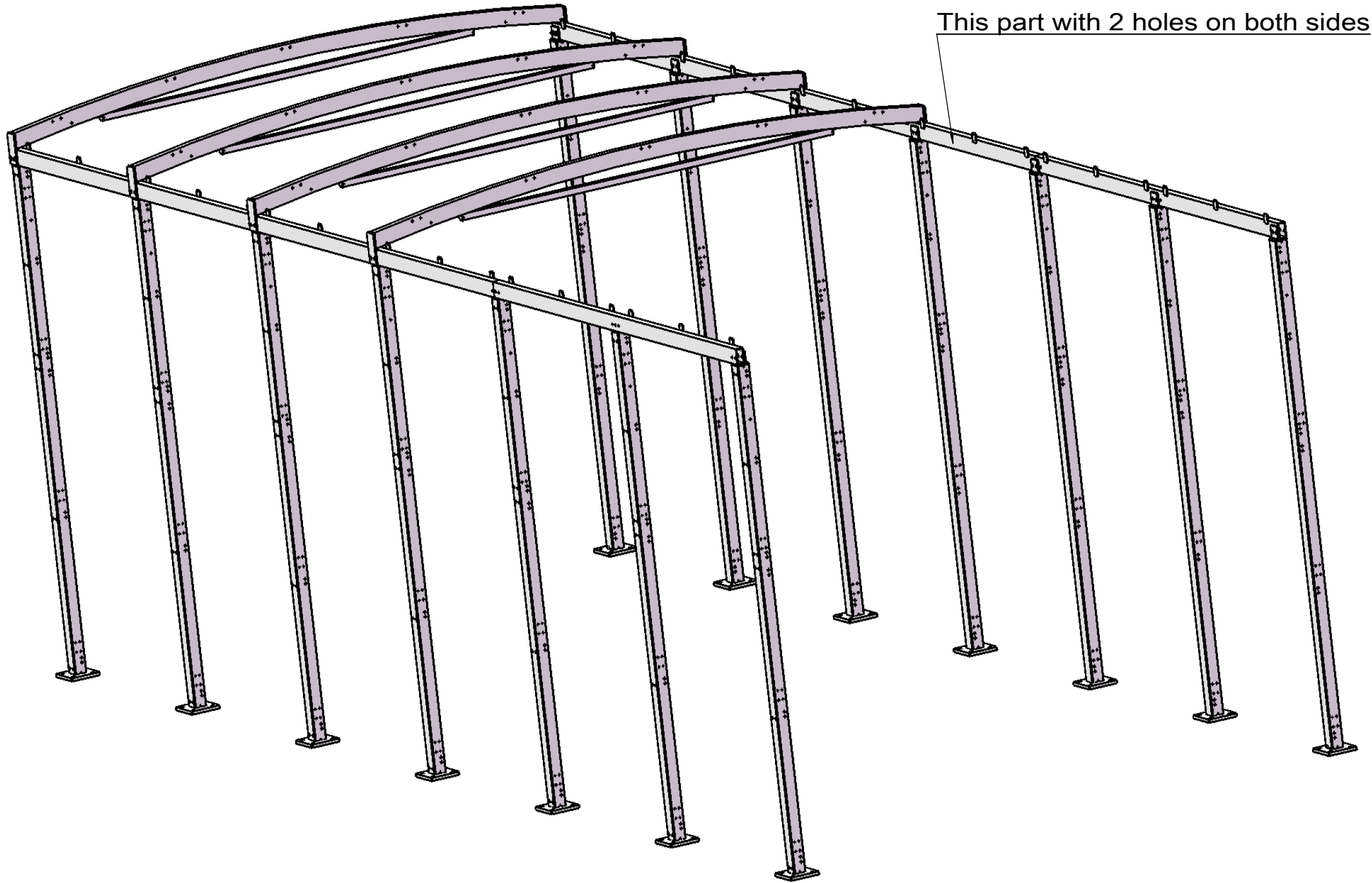

This part with 2 holes on both sides

Use the below standards to fix
M12X90 bolt
M12 flat washer
M12 spring washer
M12 nut

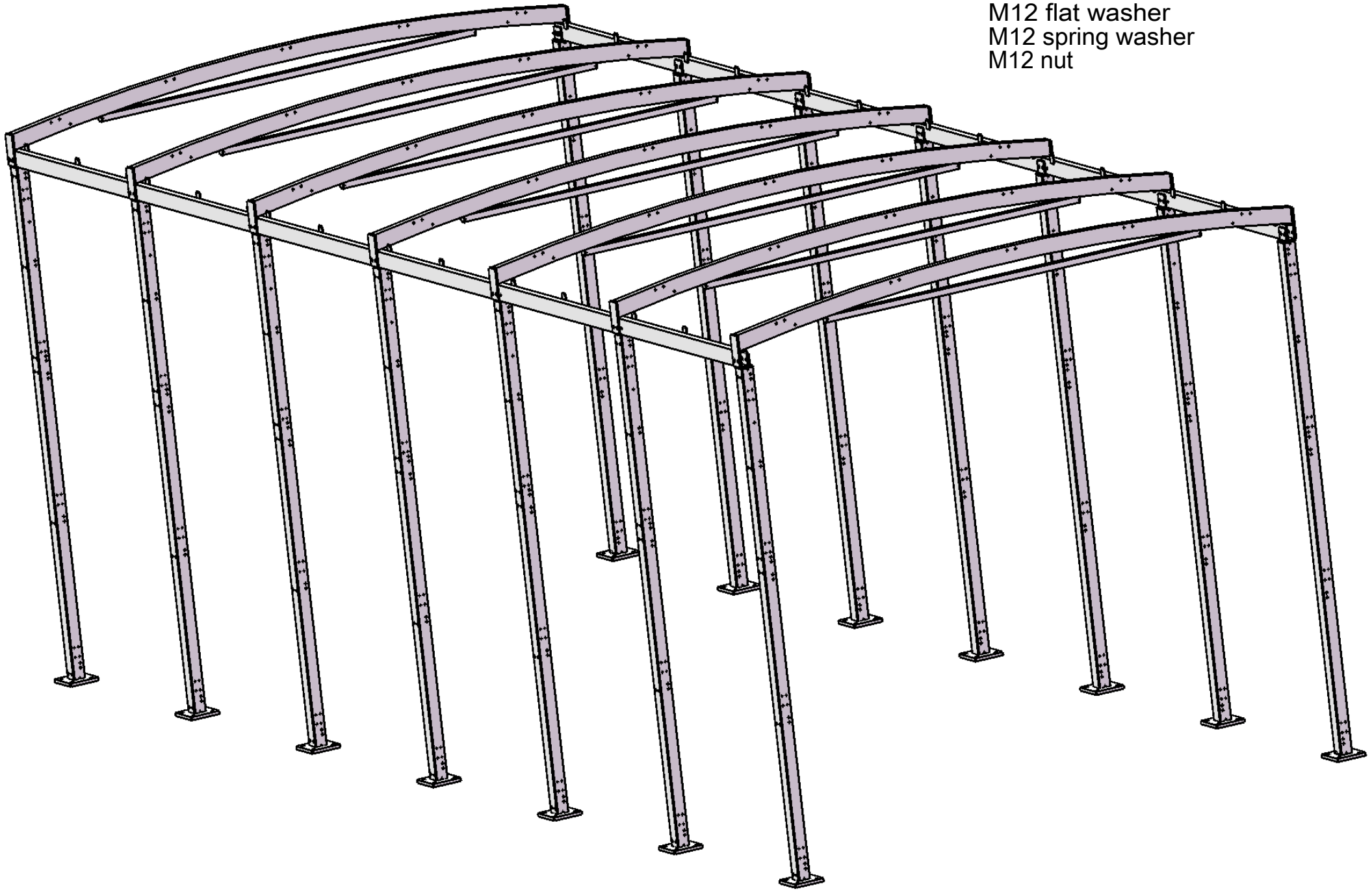

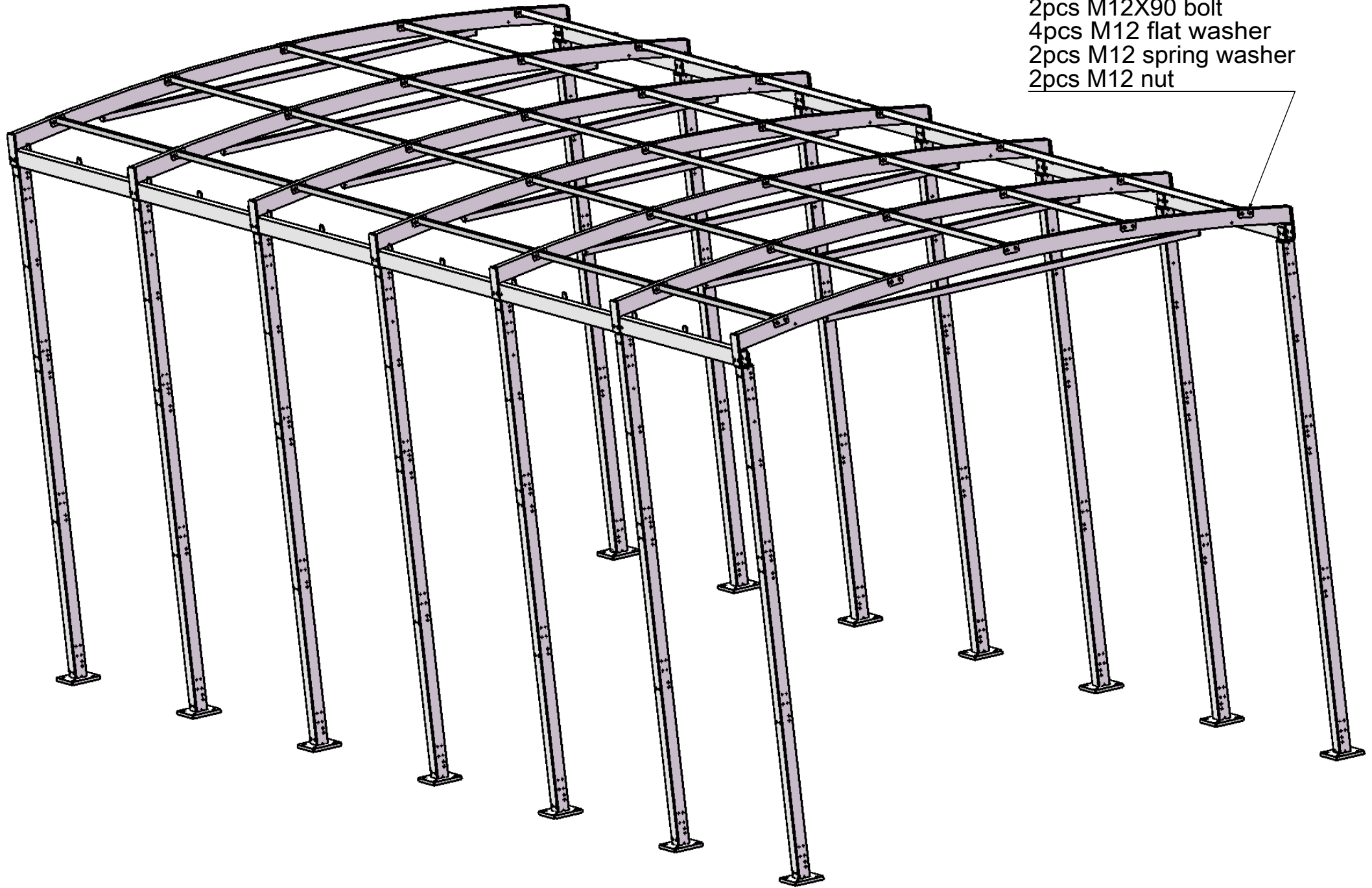

2pcs M12X90 bolt
4pcs M12 flat washer
2pcs M12 spring washer
2pcs M12 nut

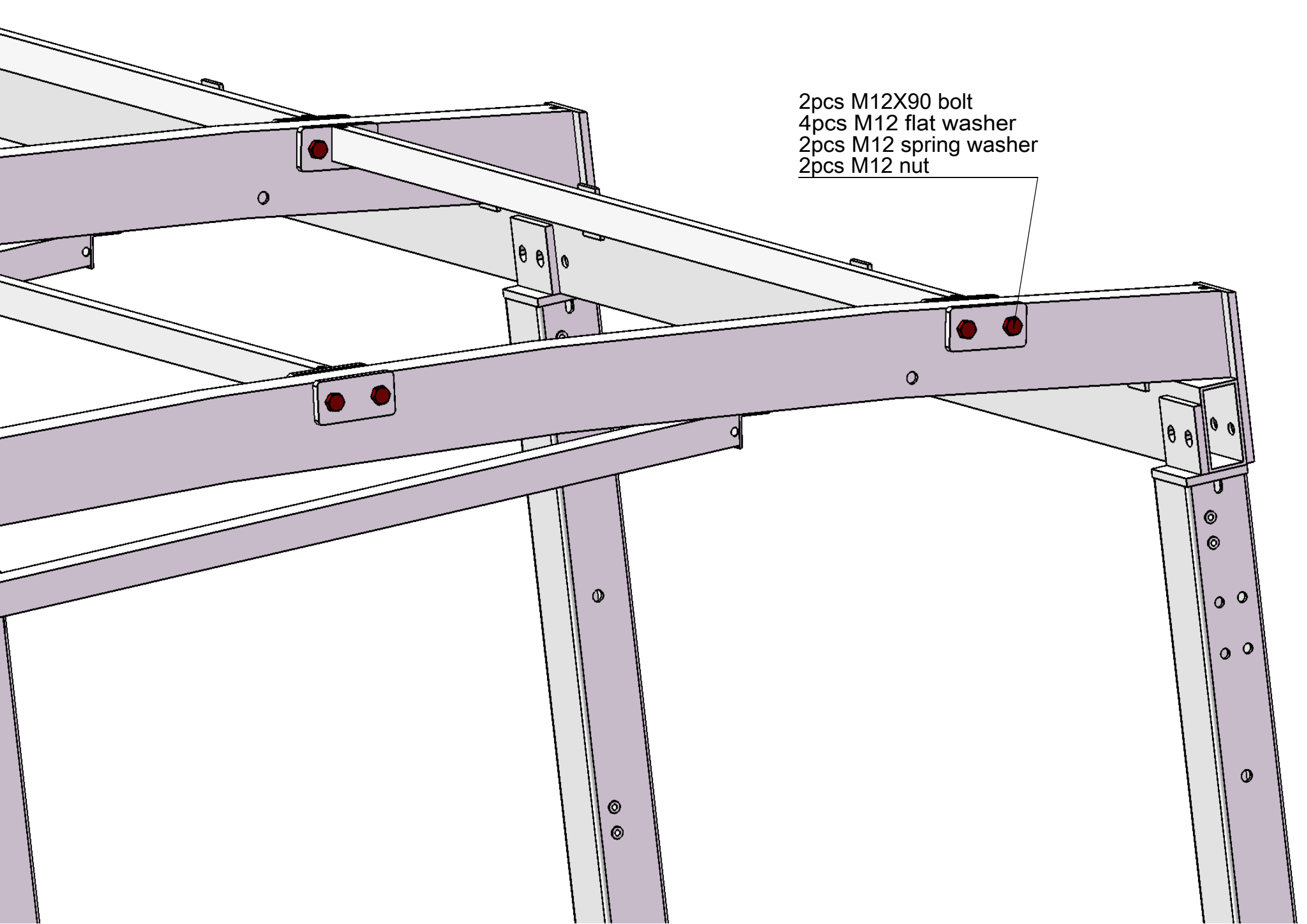

2pcs M12X90 bolt
4pcs M12 flat washer
2pcs M12 spring washer
2pcs M12 nut

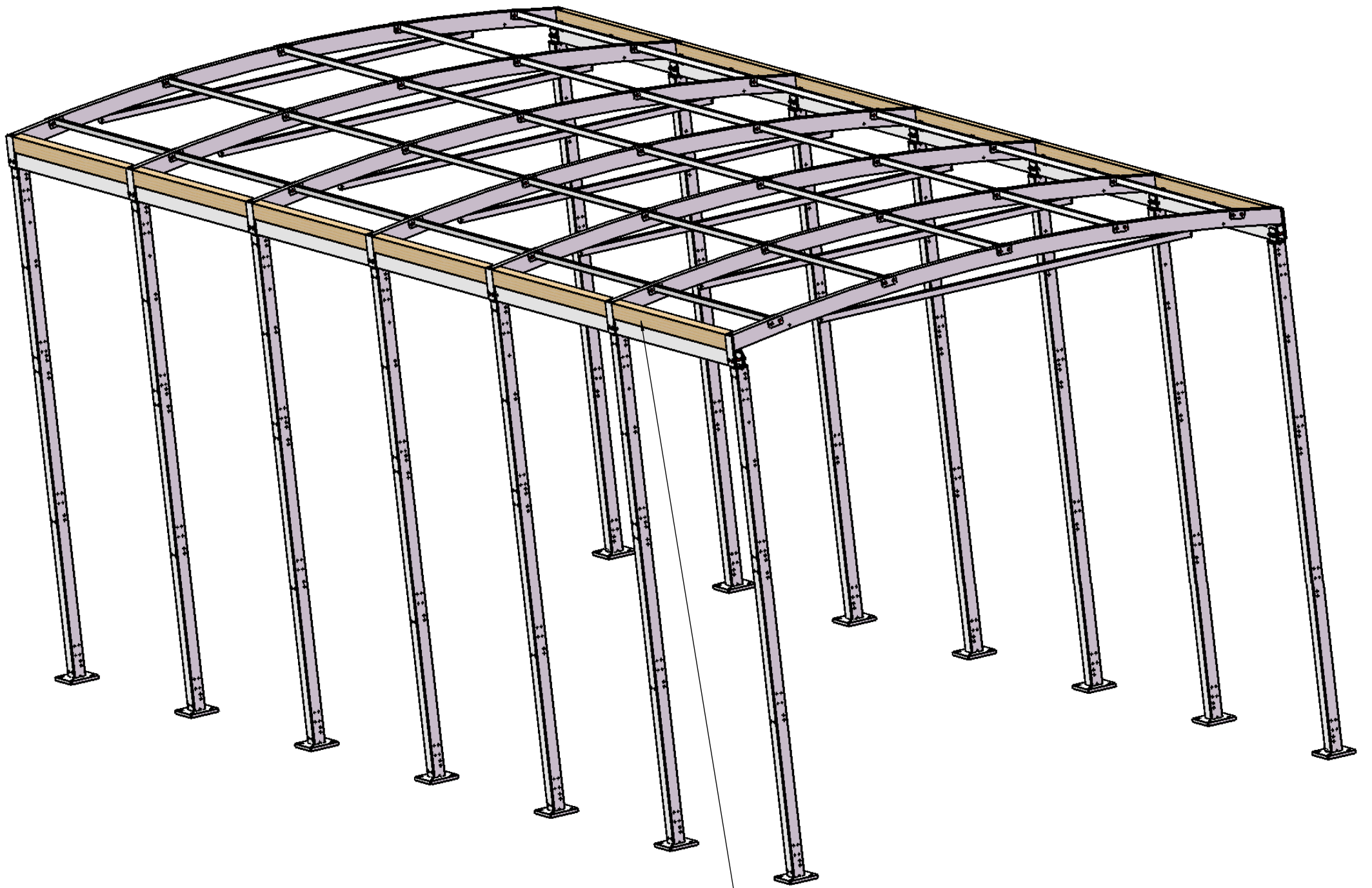

Put 6pcs wood on both sides like the picture show

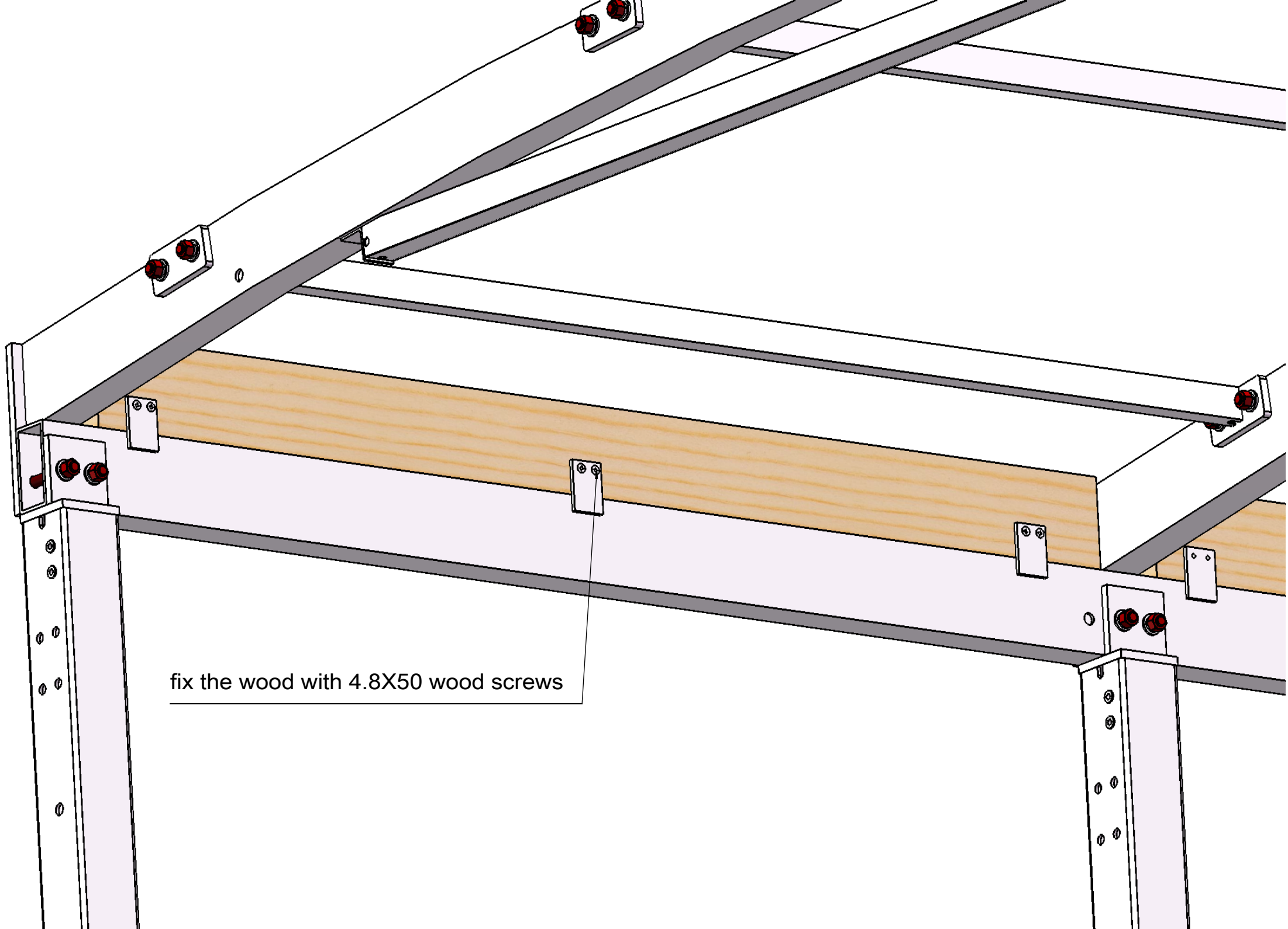

fix the wood with 4.8X50 wood screws

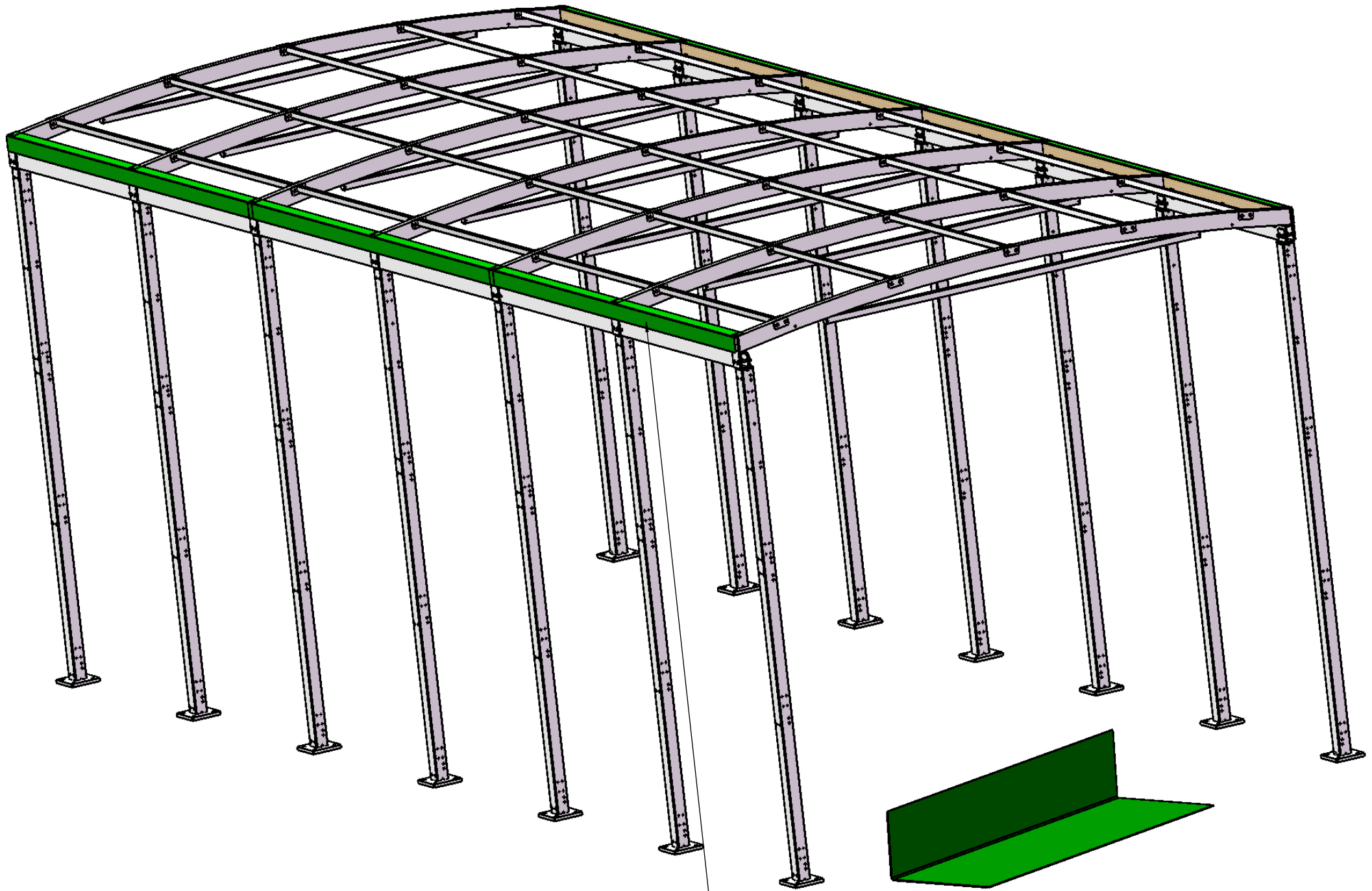

Put 3pcs PVC coated angle steels on both sides like the picture show

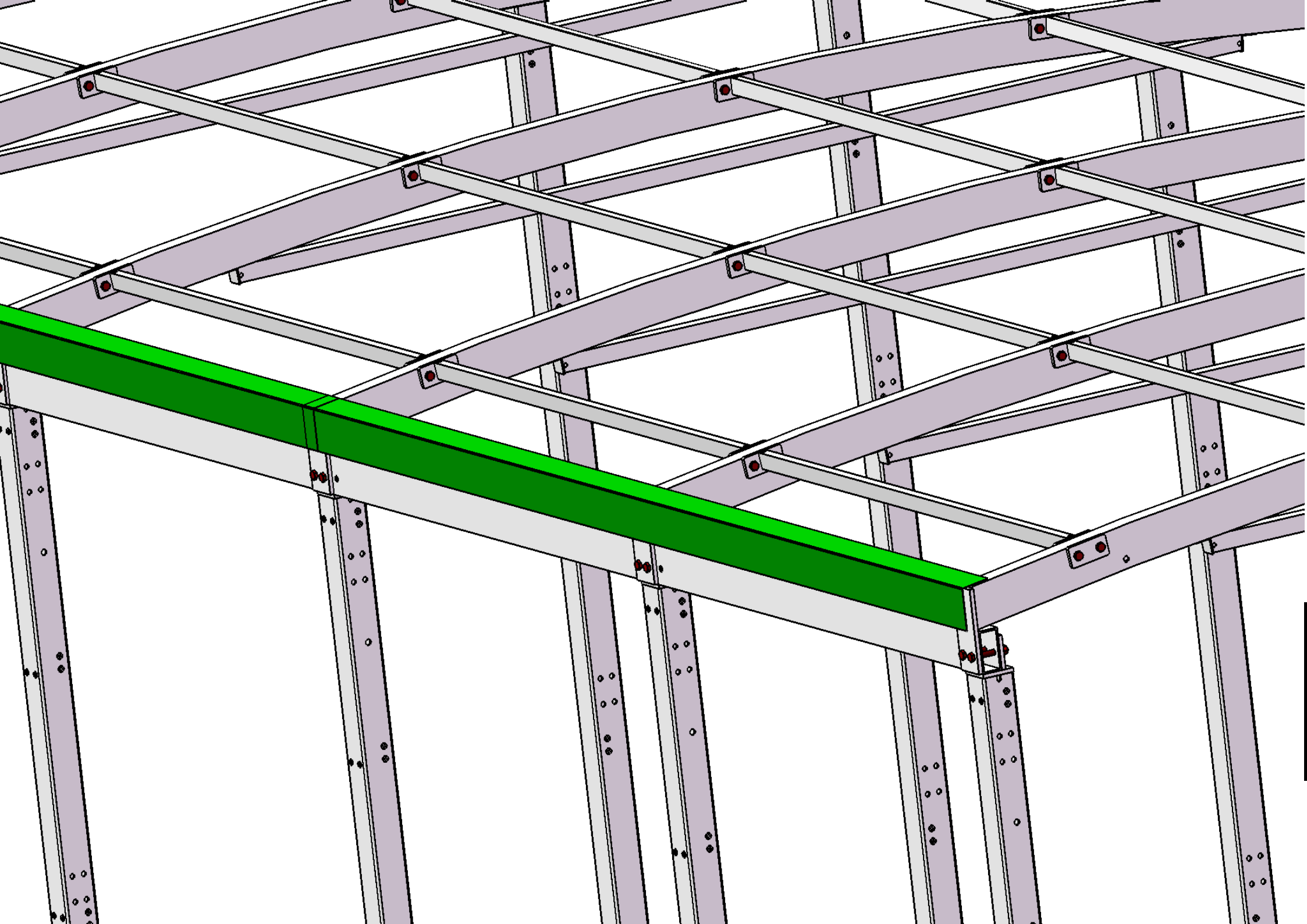

Put the corrugated FRP plate on the top.
Connect with the self-tapping screws

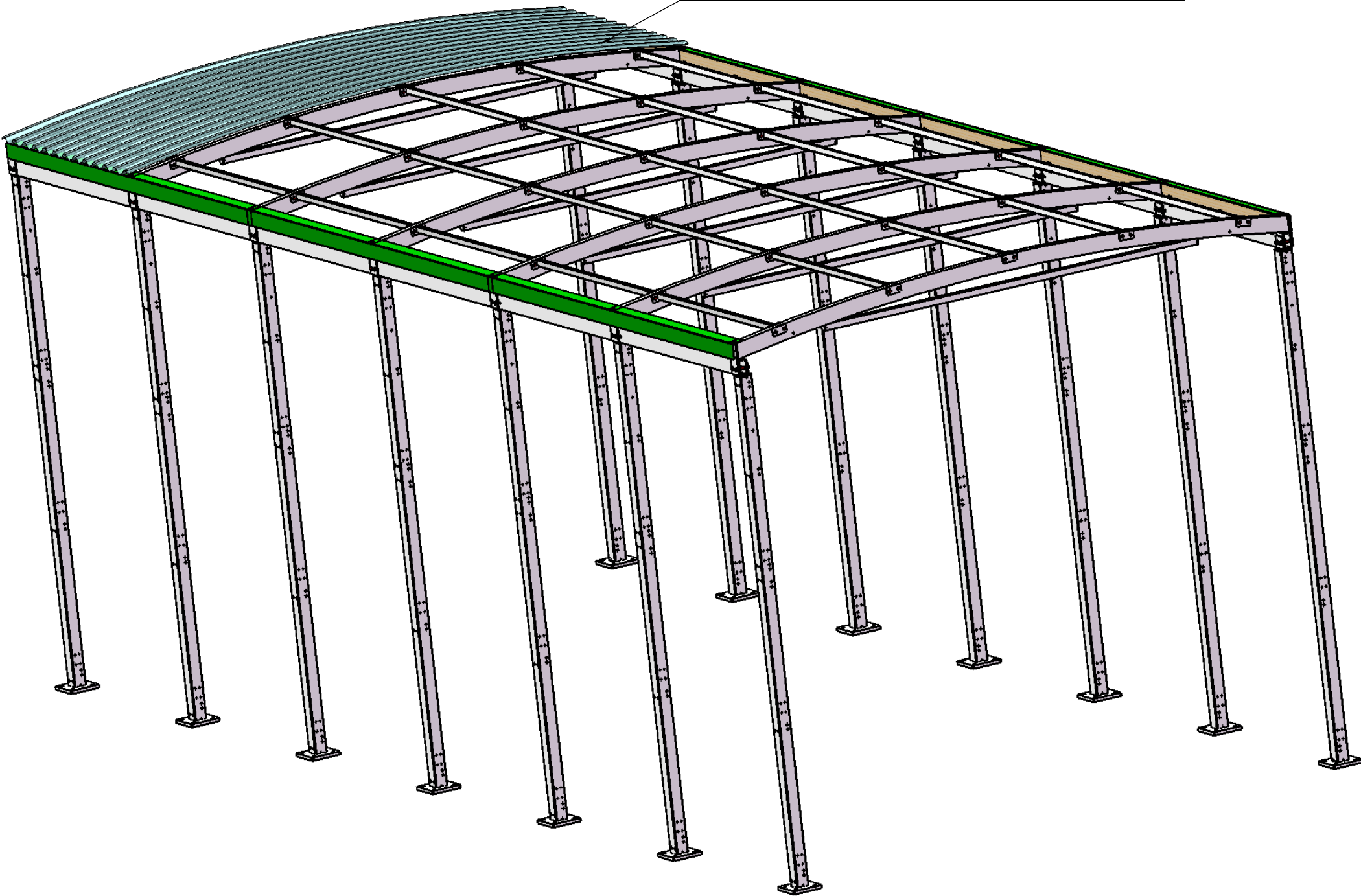

Put the corrugated FRP plate on the top.
Connect with the self-tapping screws

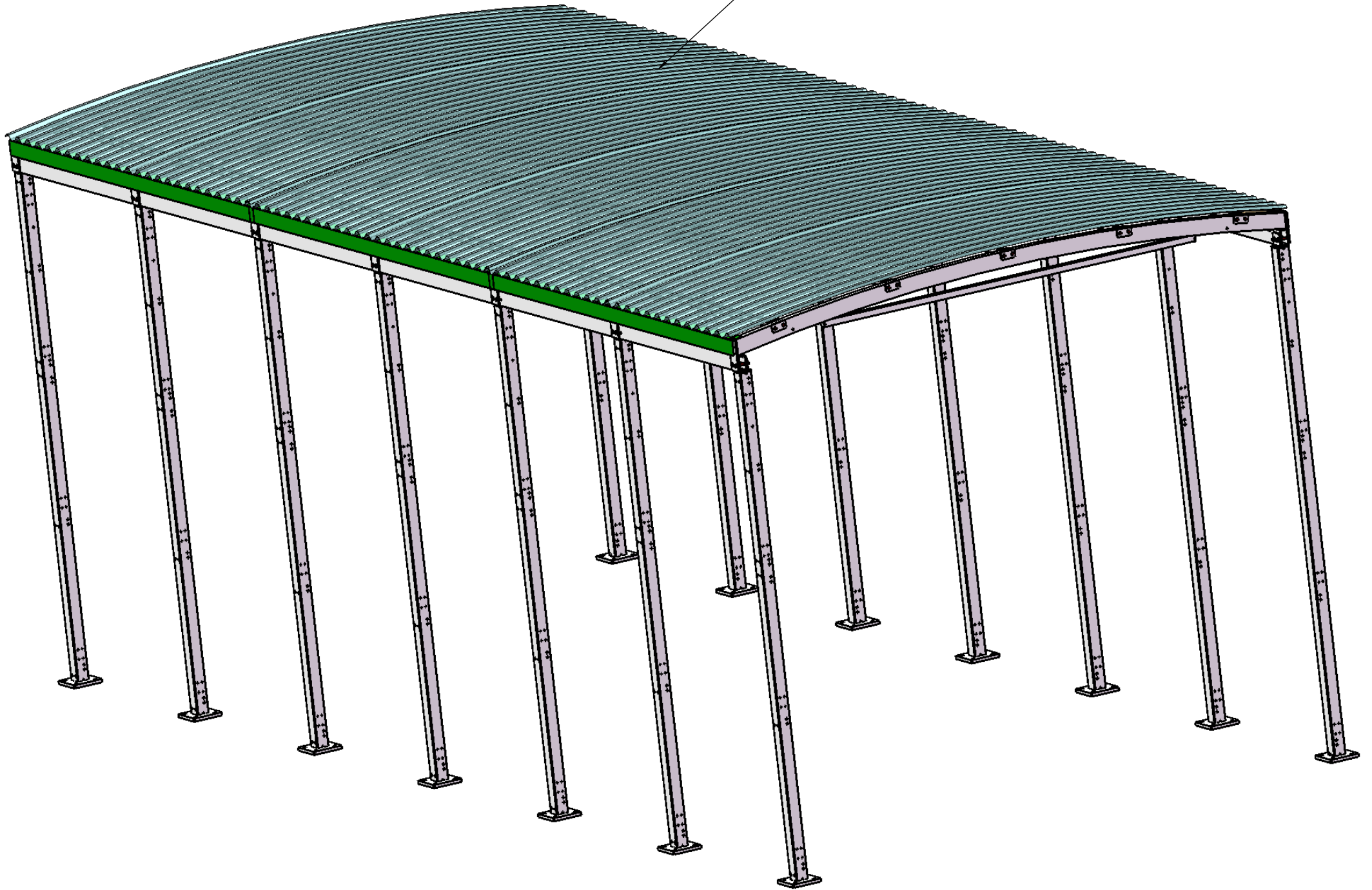

window frame installed

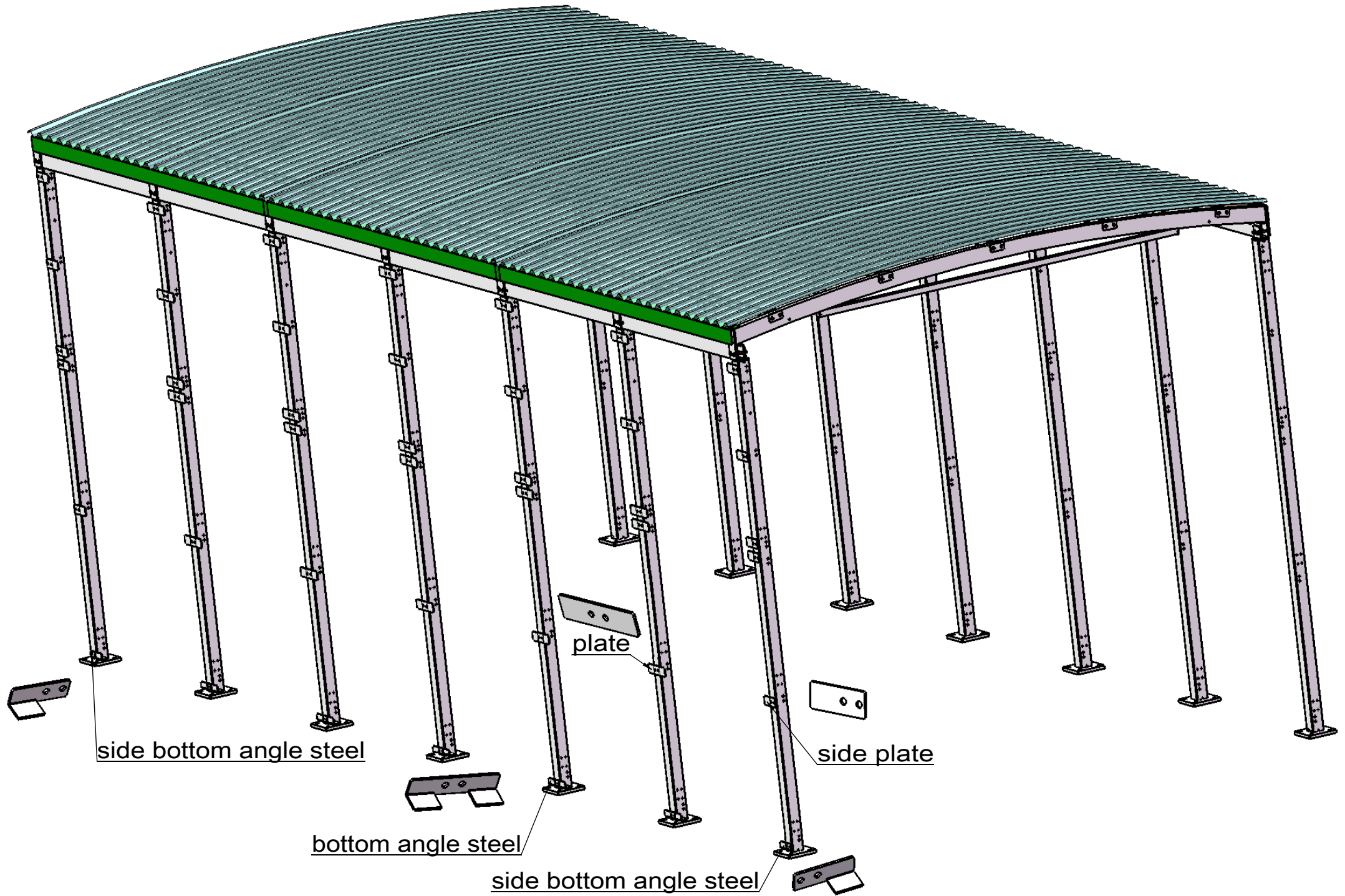

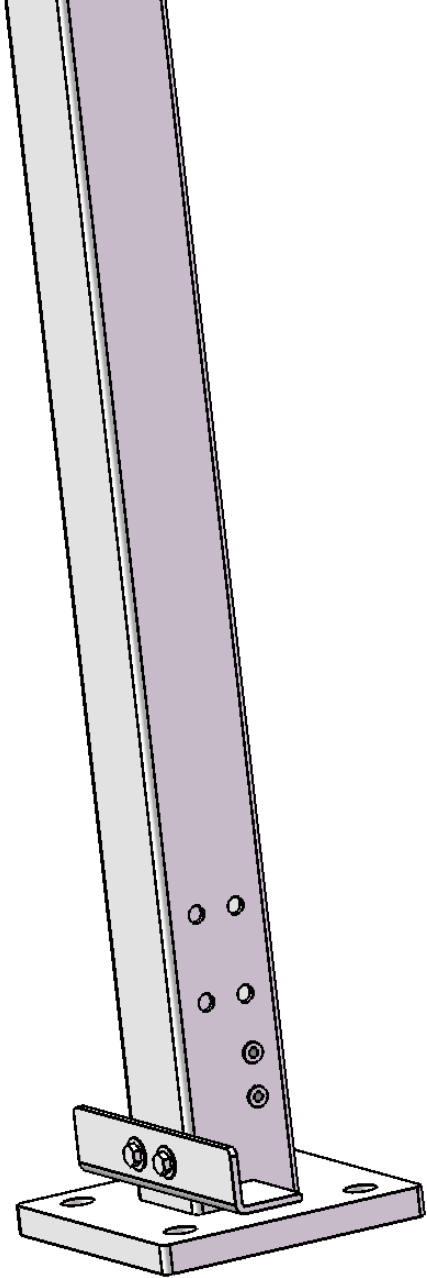

2pcs M8X20 bolt
2pcs M8 flat washer
2pcs M8 spring washer

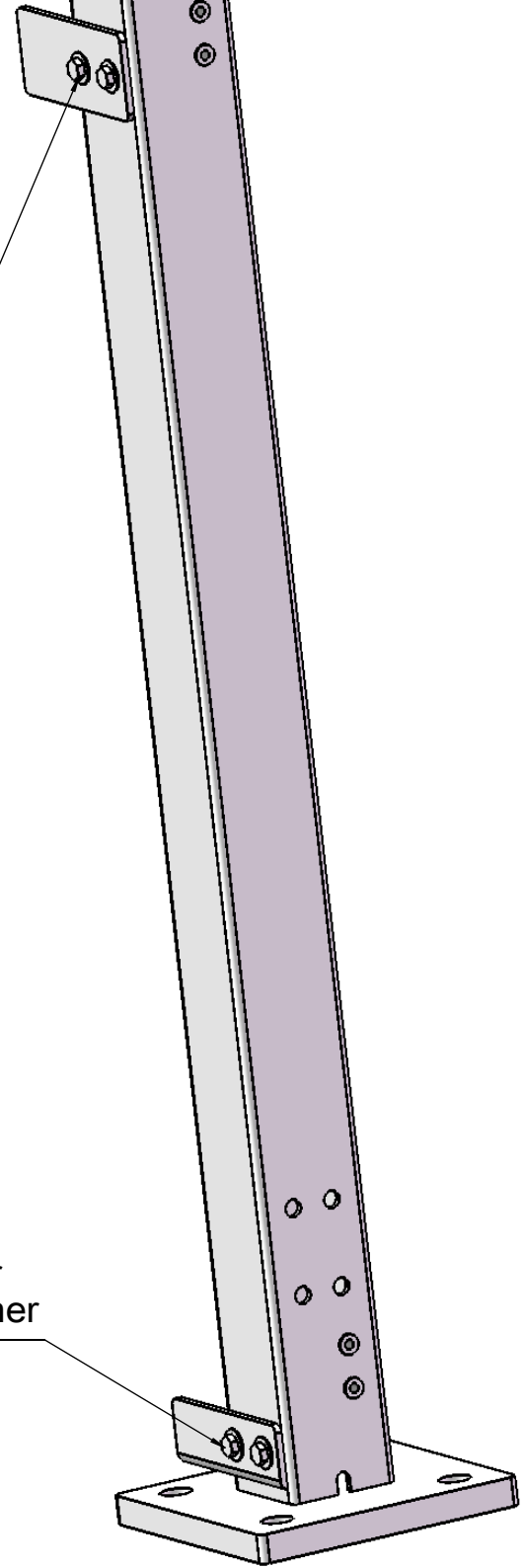

2pcs M8X20 bolt
2pcs M8 flat washer
2pcs M8 spring washer

window frame installed

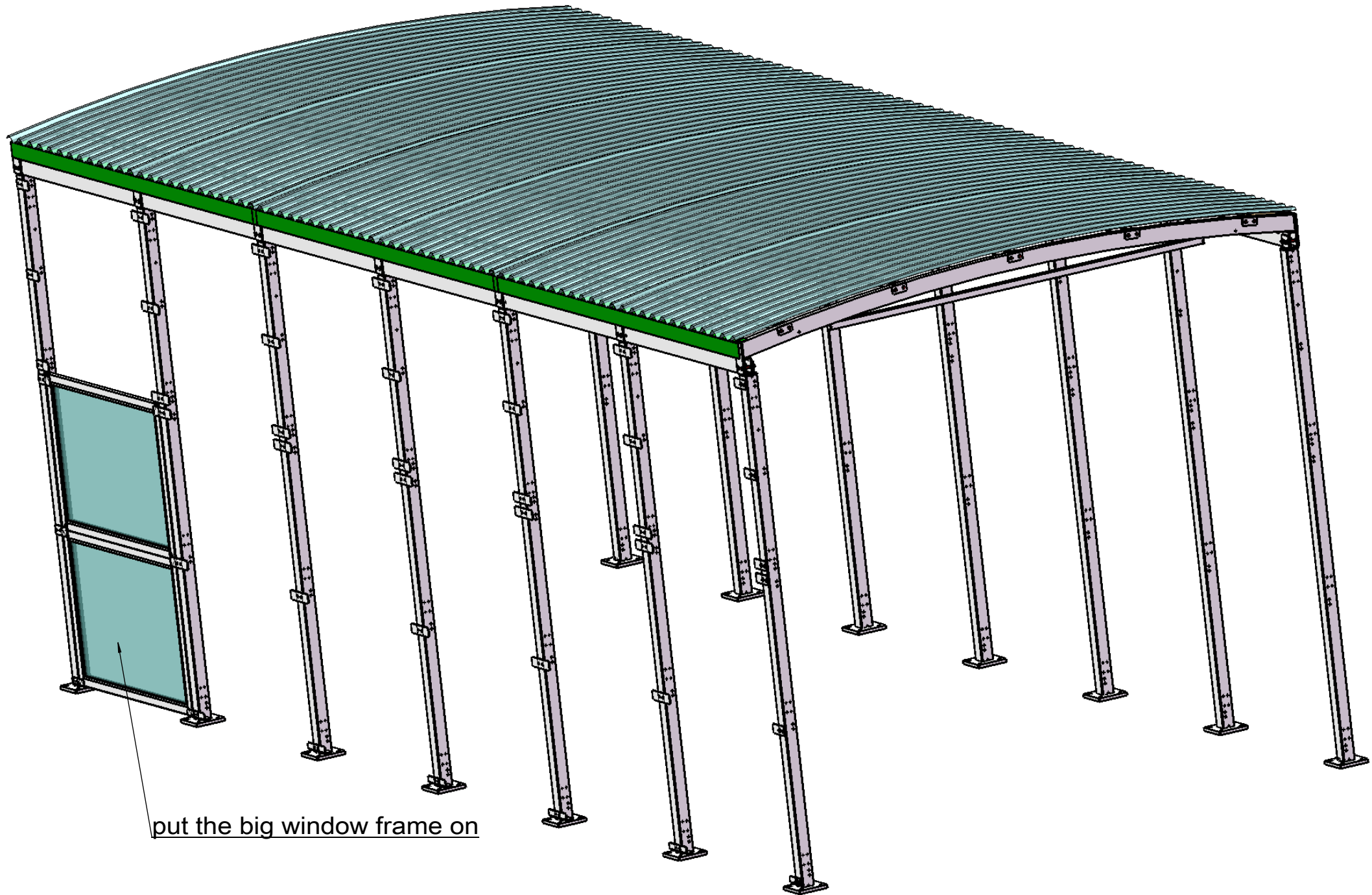

put the big window frame on

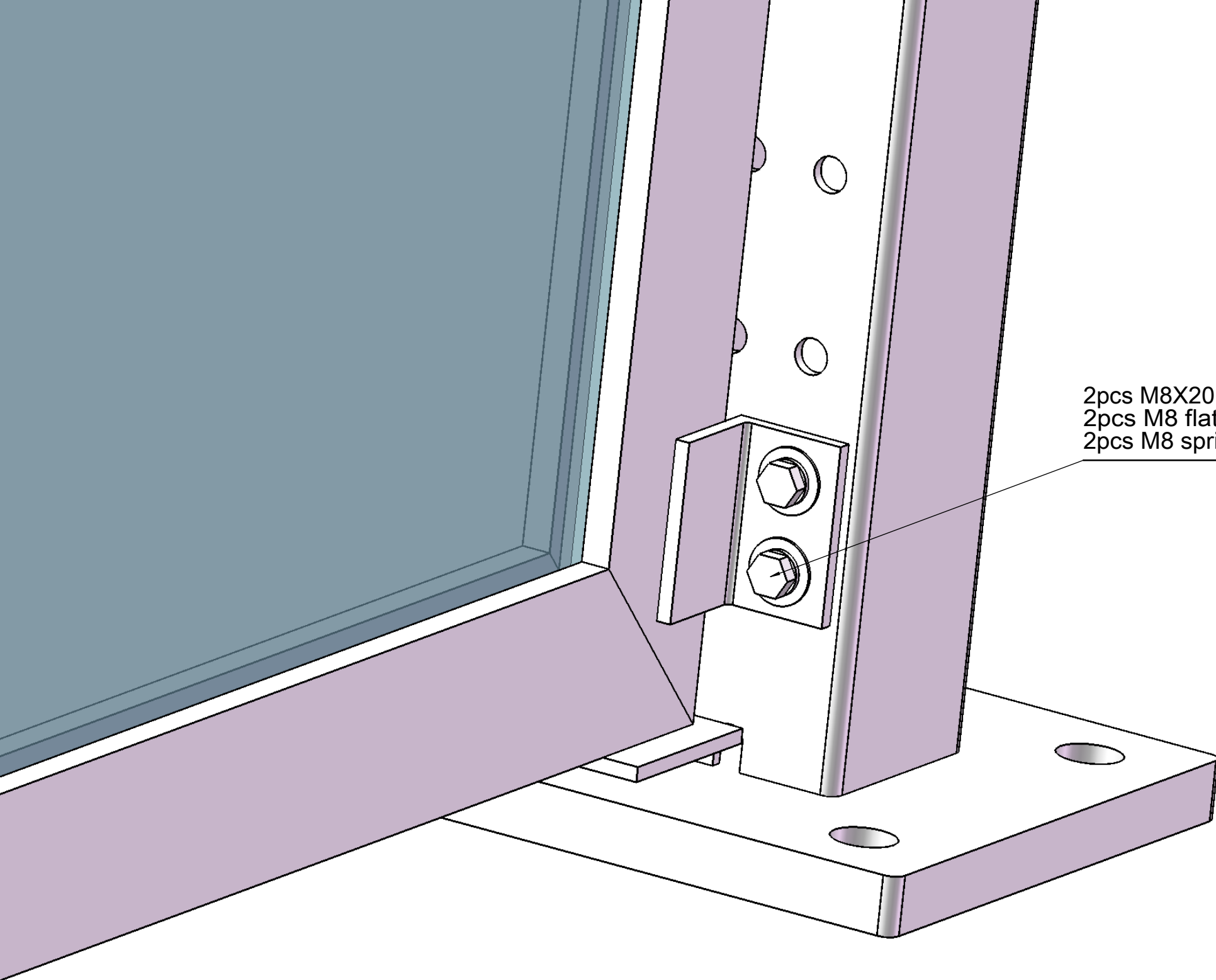

2pcs M8X20 bolt
2pcs M8 flat washer
2pcs M8 spring washer

window frame installed

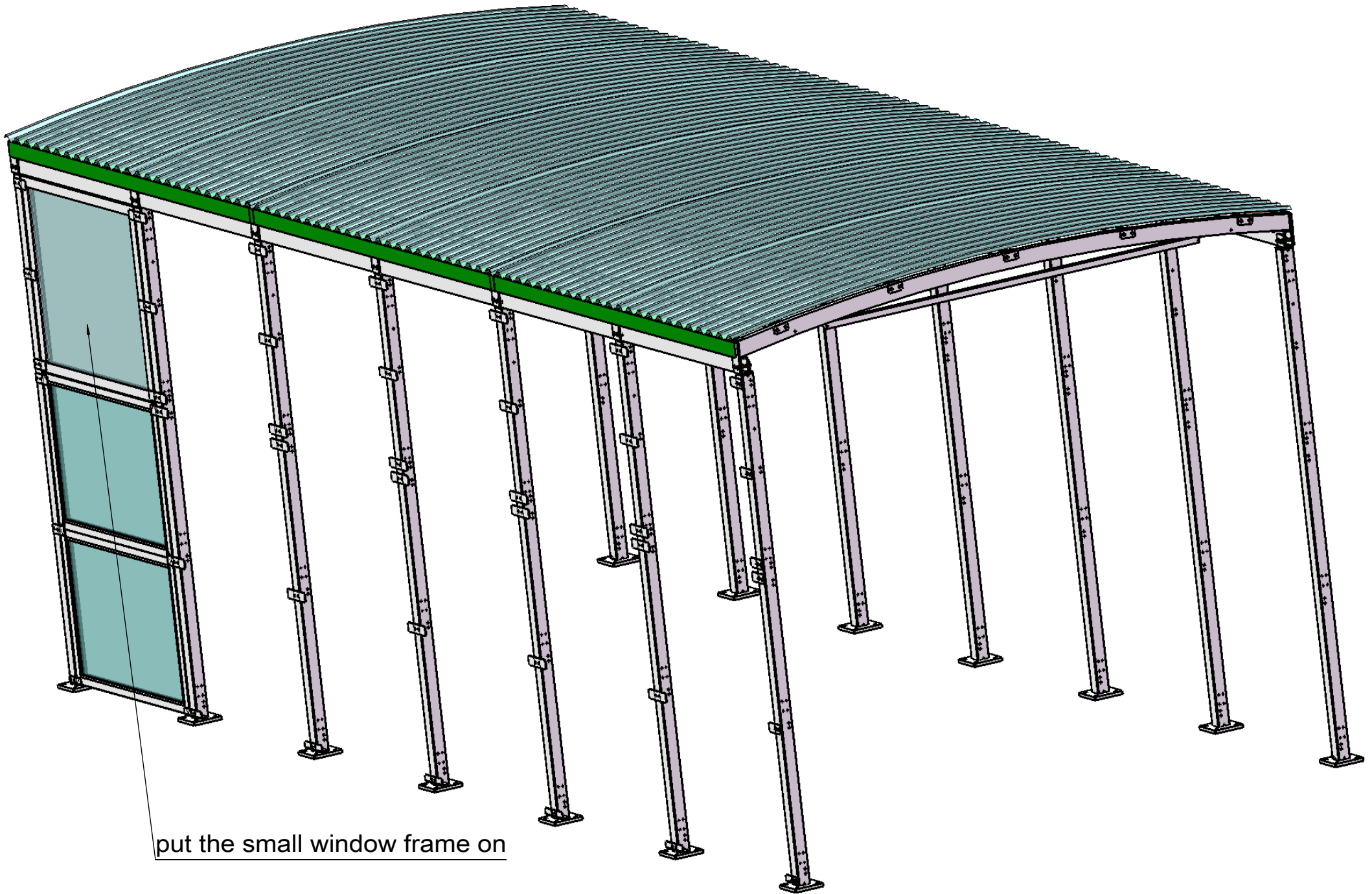

put the small window frame on

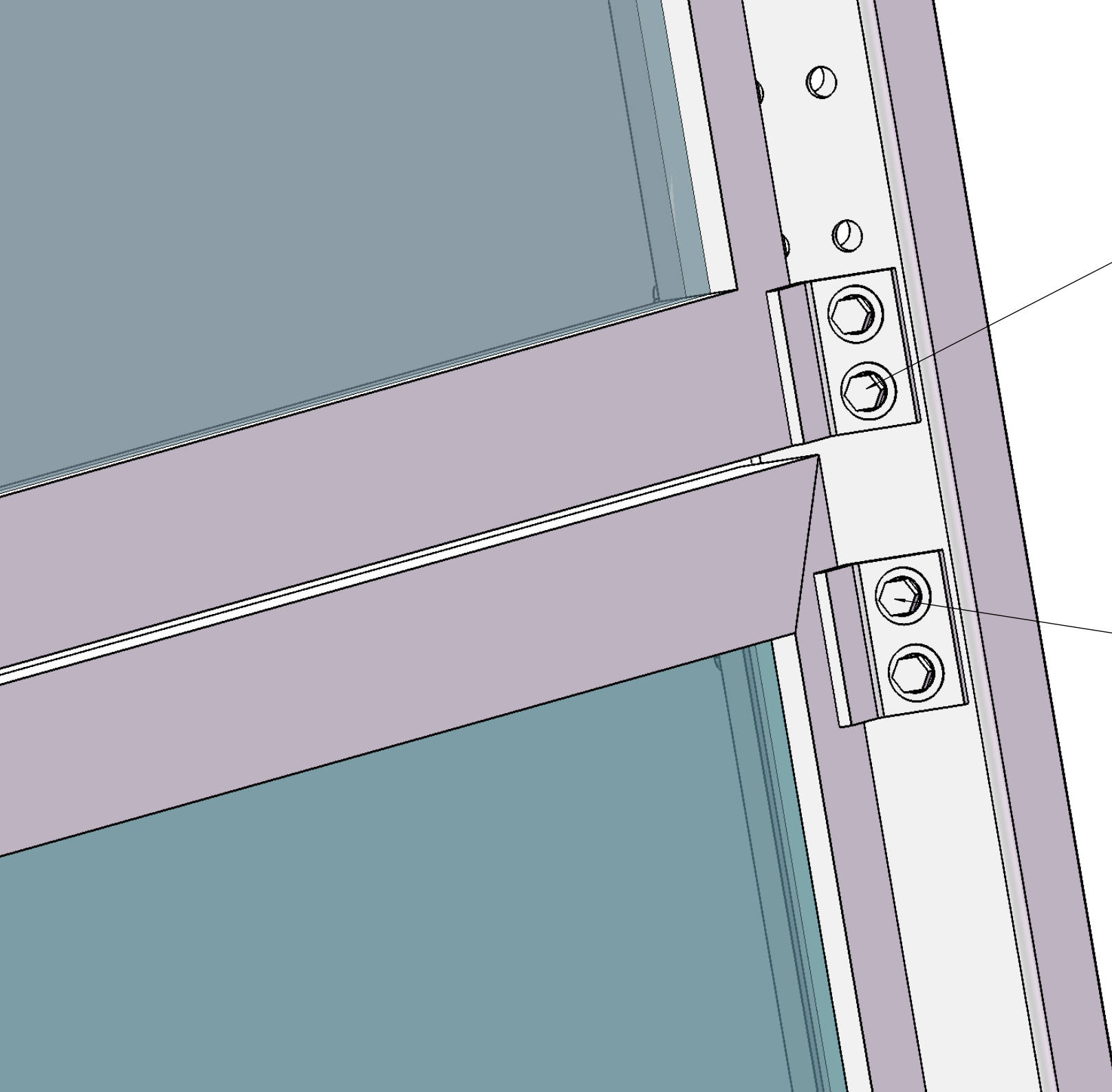

2pcs M8X20 bolt
2pcs M8 flat washer
2pcs M8 spring washer

2pcs M8X20 bolt
2pcs M8 flat washer
2pcs M8 spring washer

window frame installed

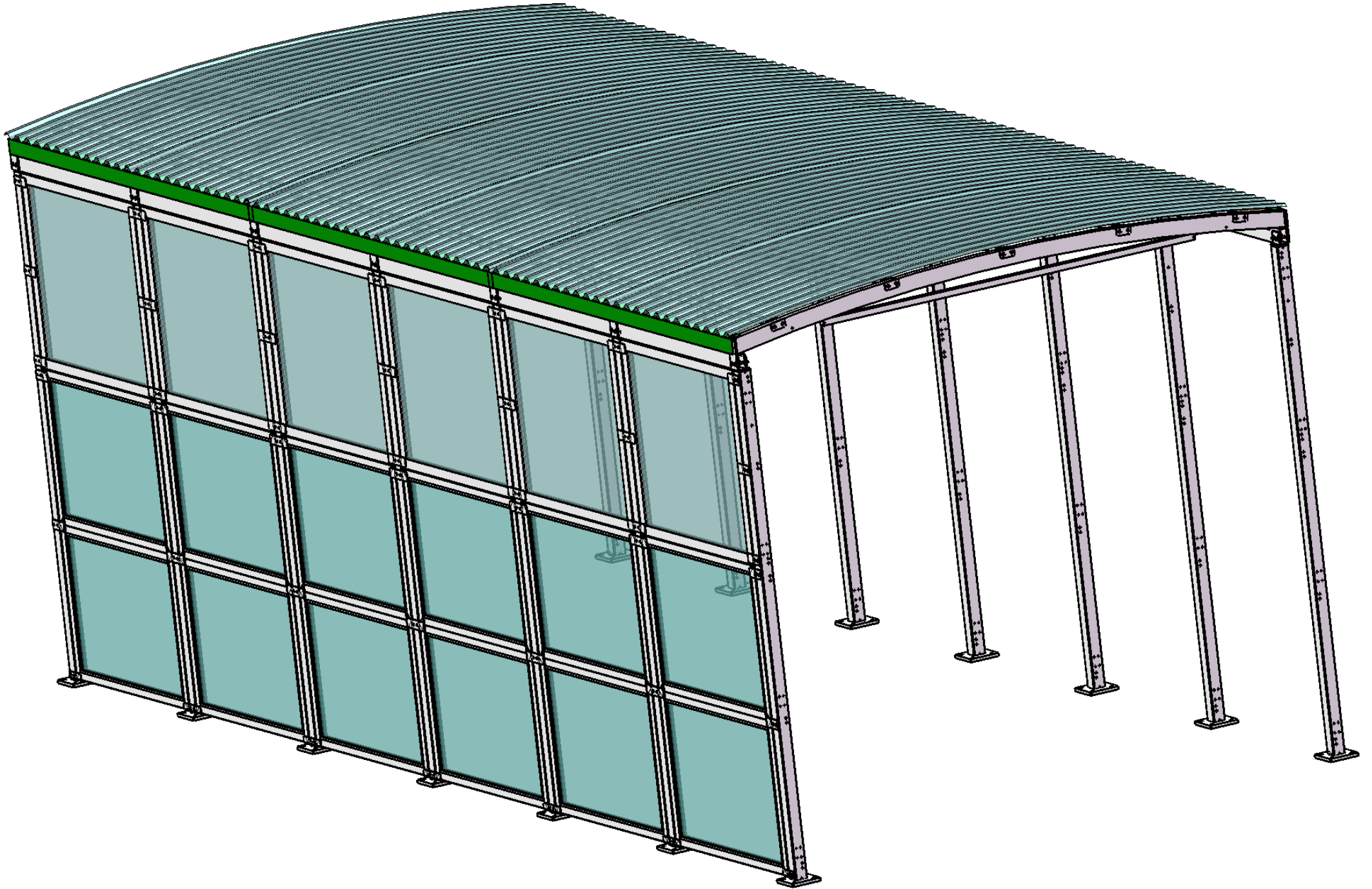

FRP plate installed

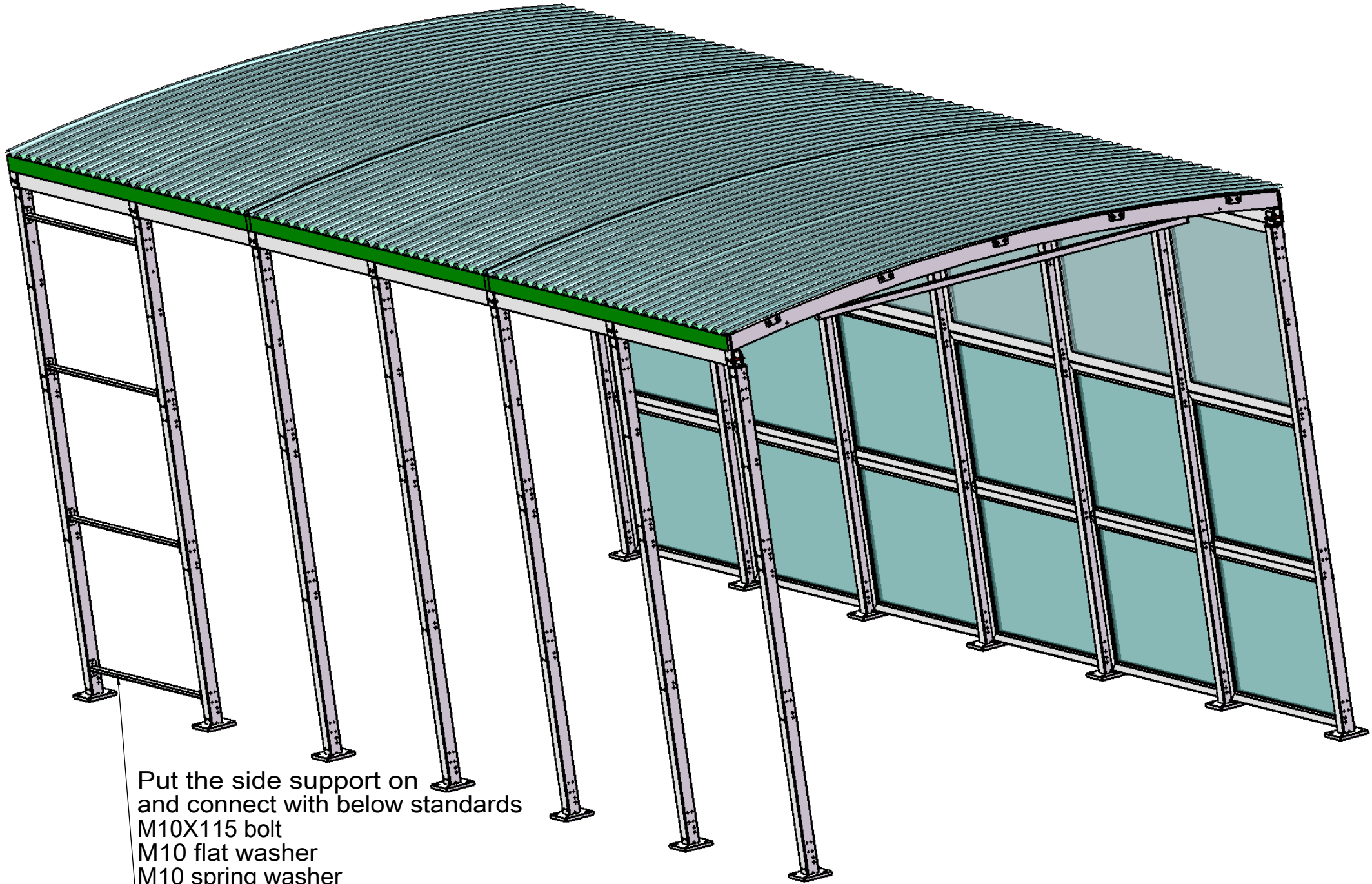

Put the side support on
and connect with below standards
M10X115 bolt
M10 flat washer
M10 spring washer
M10 nut

FRP plate installed

2pcs M10X115 bolt
4pcs flat washer
2pcs spring washer
2pcs M10 nut

Pay attention to here.
Here need to be flat with the post

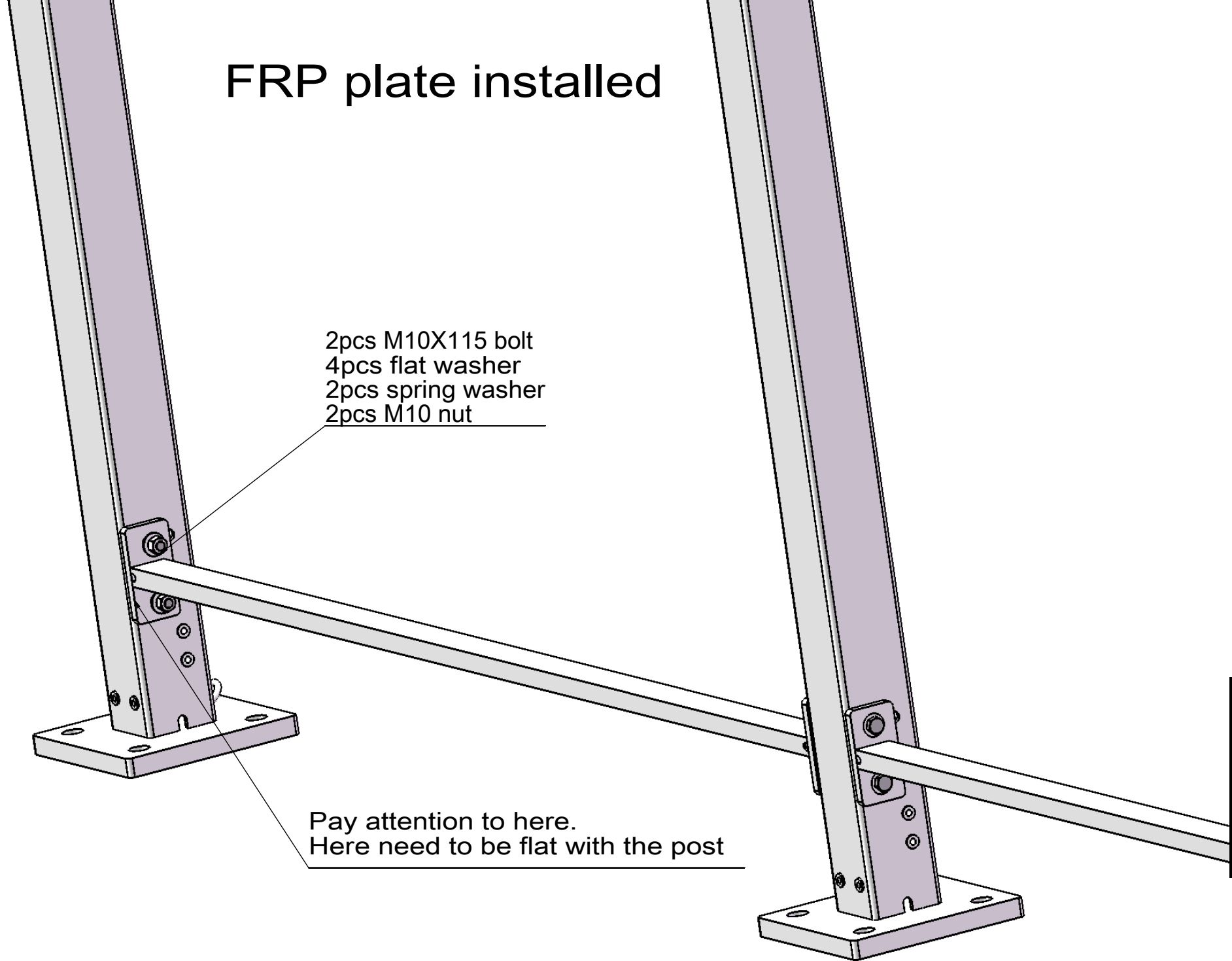

FRP plate installed

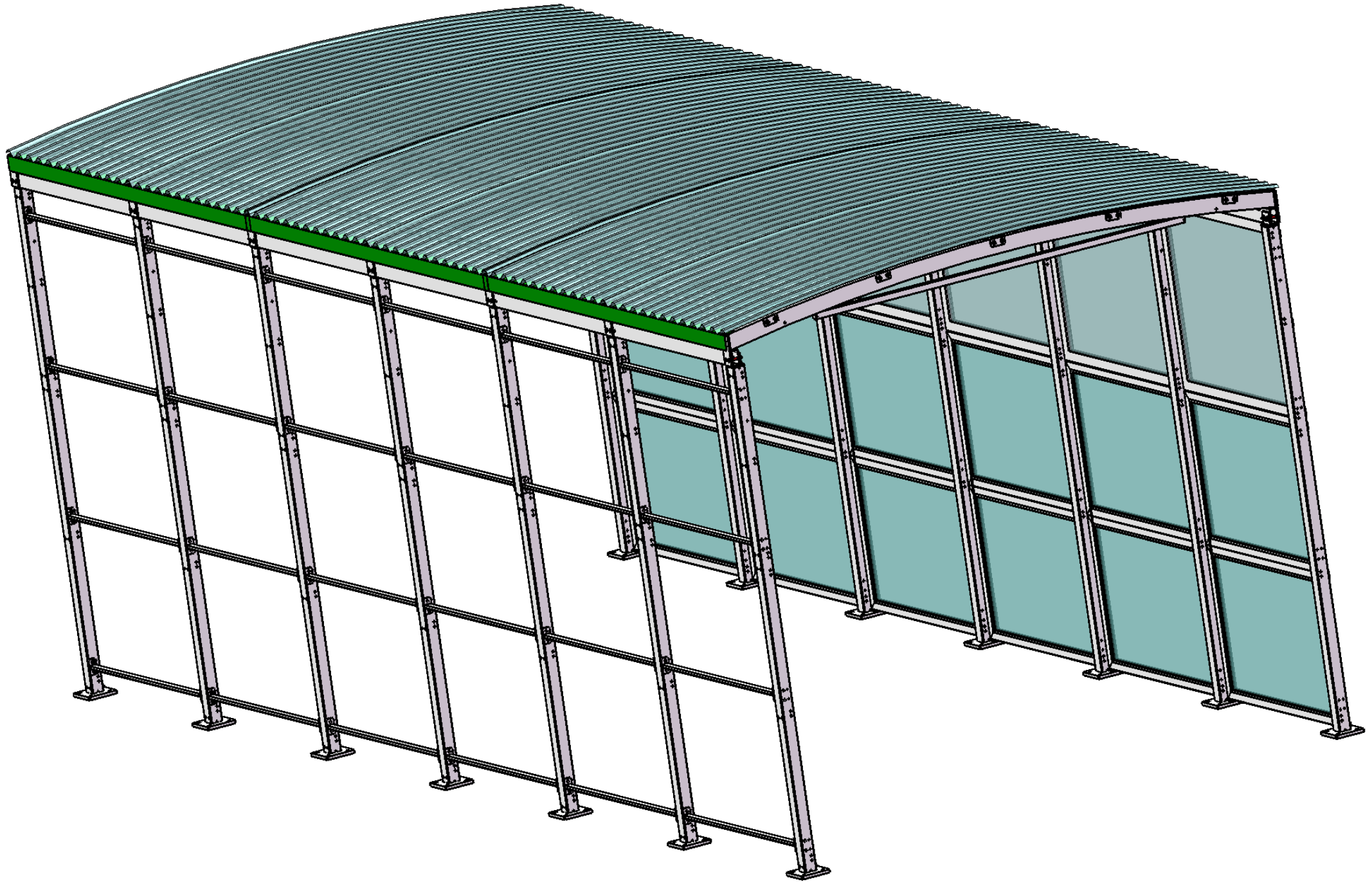

FRP plate installed

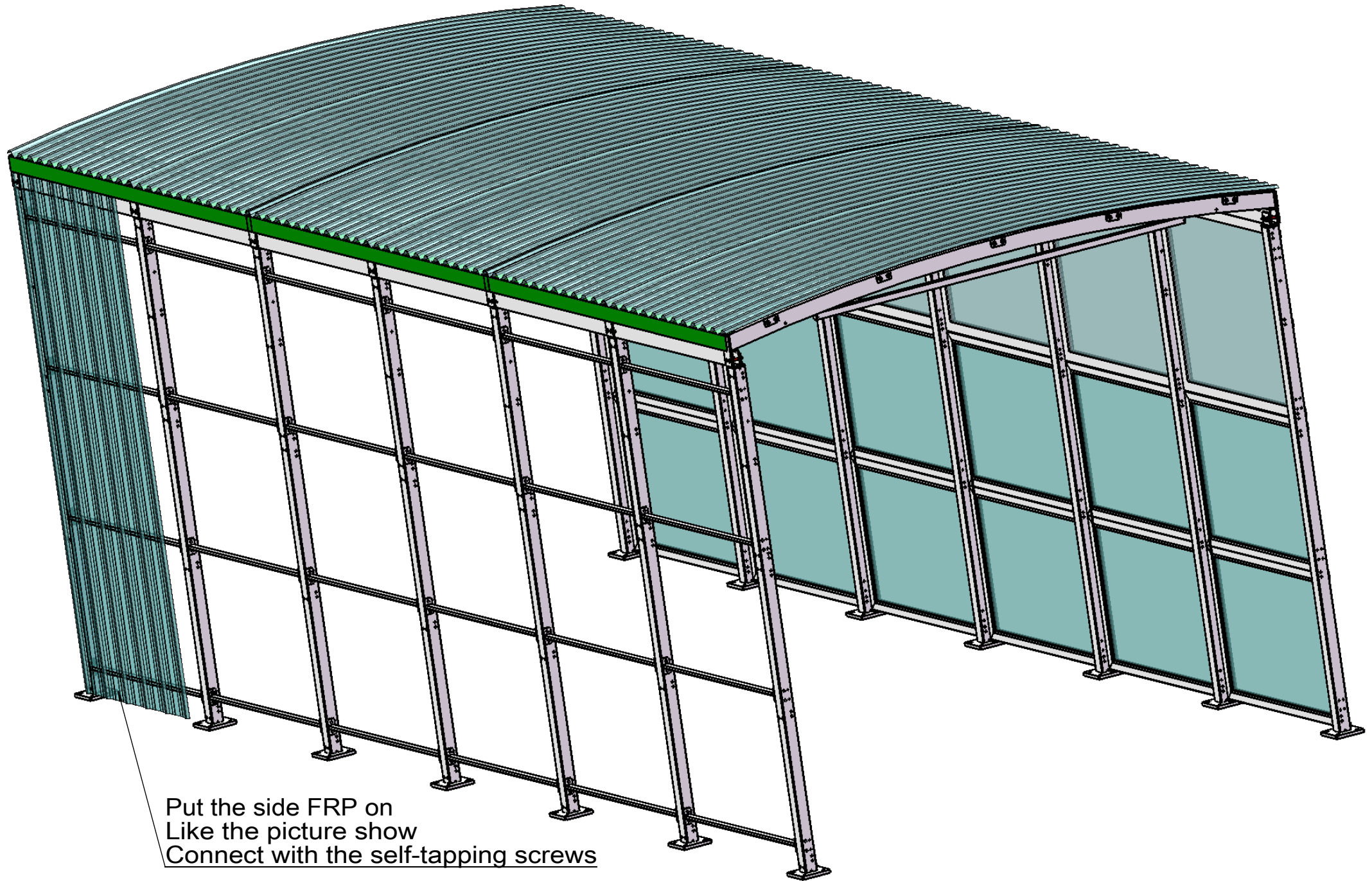

Put the side FRP on
Like the picture show
Connect with the self-tapping screws

FRP plate installed

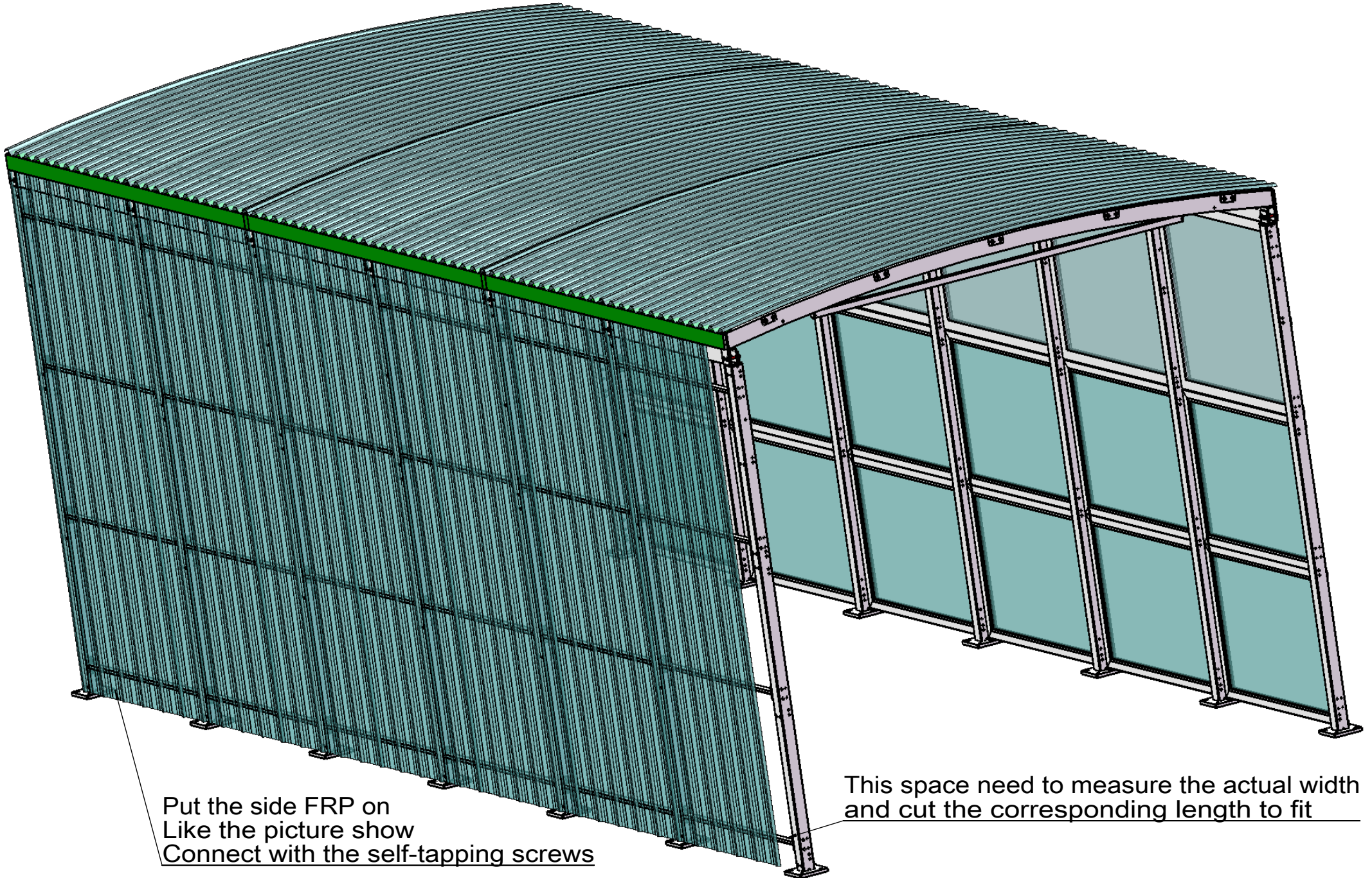

Put the side FRP on
Like the picture show
Connect with the self-tapping screws

This space need to measure the actual width
and cut the corresponding length to fit

Wood plate installed

Put the side support on
and connect with below standards
M10X115 bolt
M10 flat washer
M10 spring washer
M10 nut

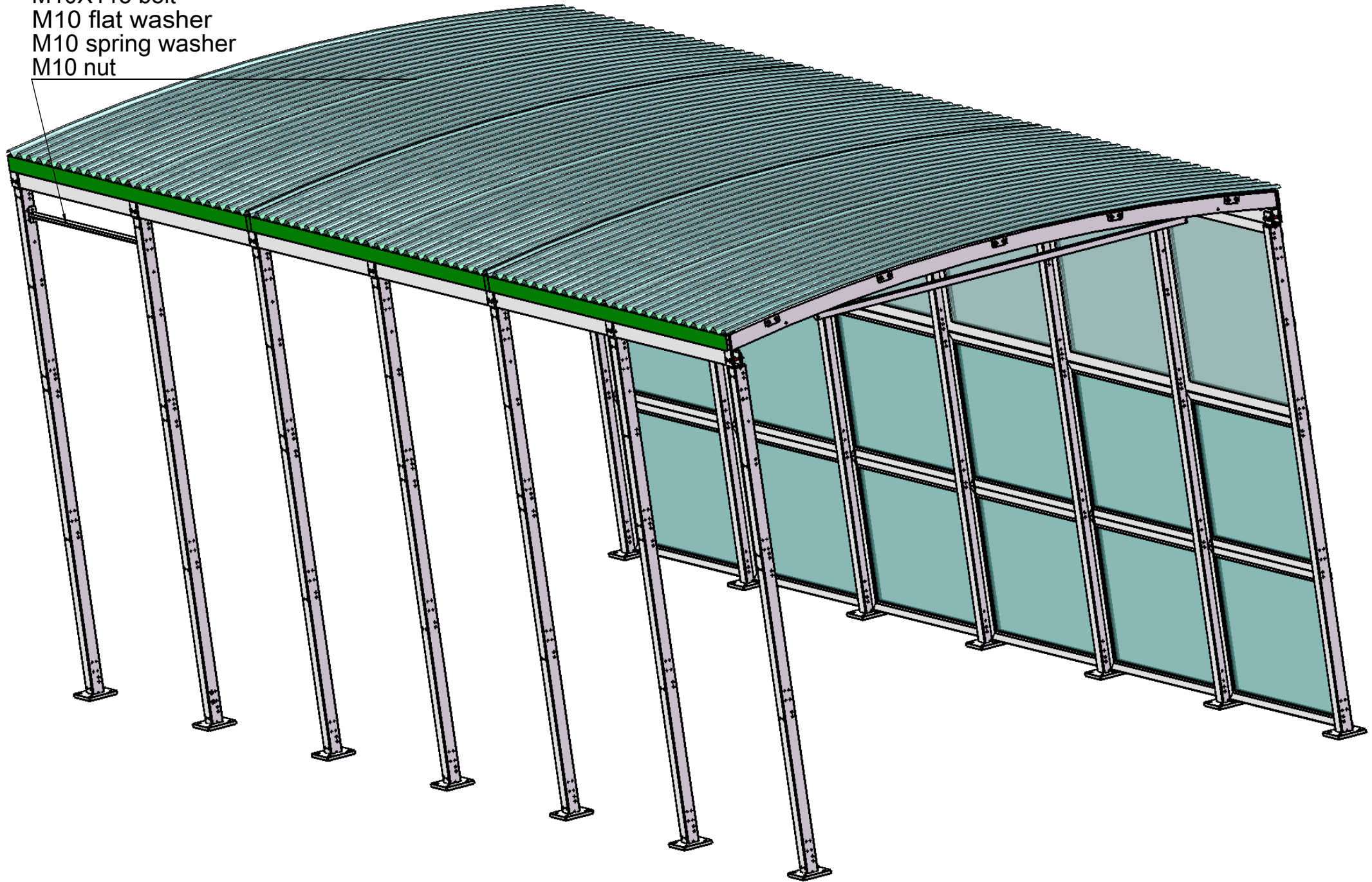

Wood plate installed

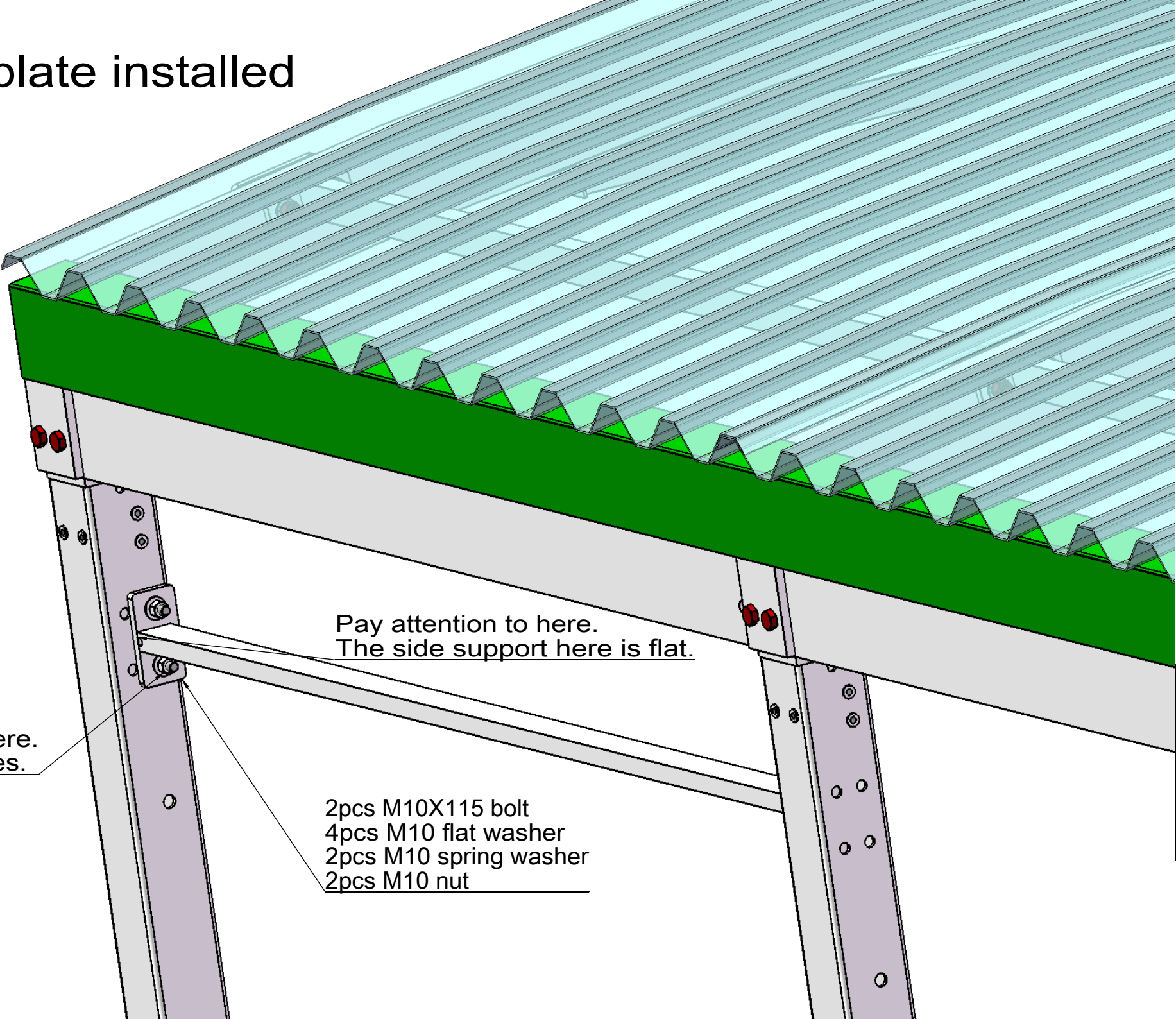

Pay attention to here.
The side support here is flat.

Pay attention to here.
Use the inside holes.

- 2pcs M10X115 bolt
- 4pcs M10 flat washer
- 2pcs M10 spring washer
- 2pcs M10 nut

Wood plate installed

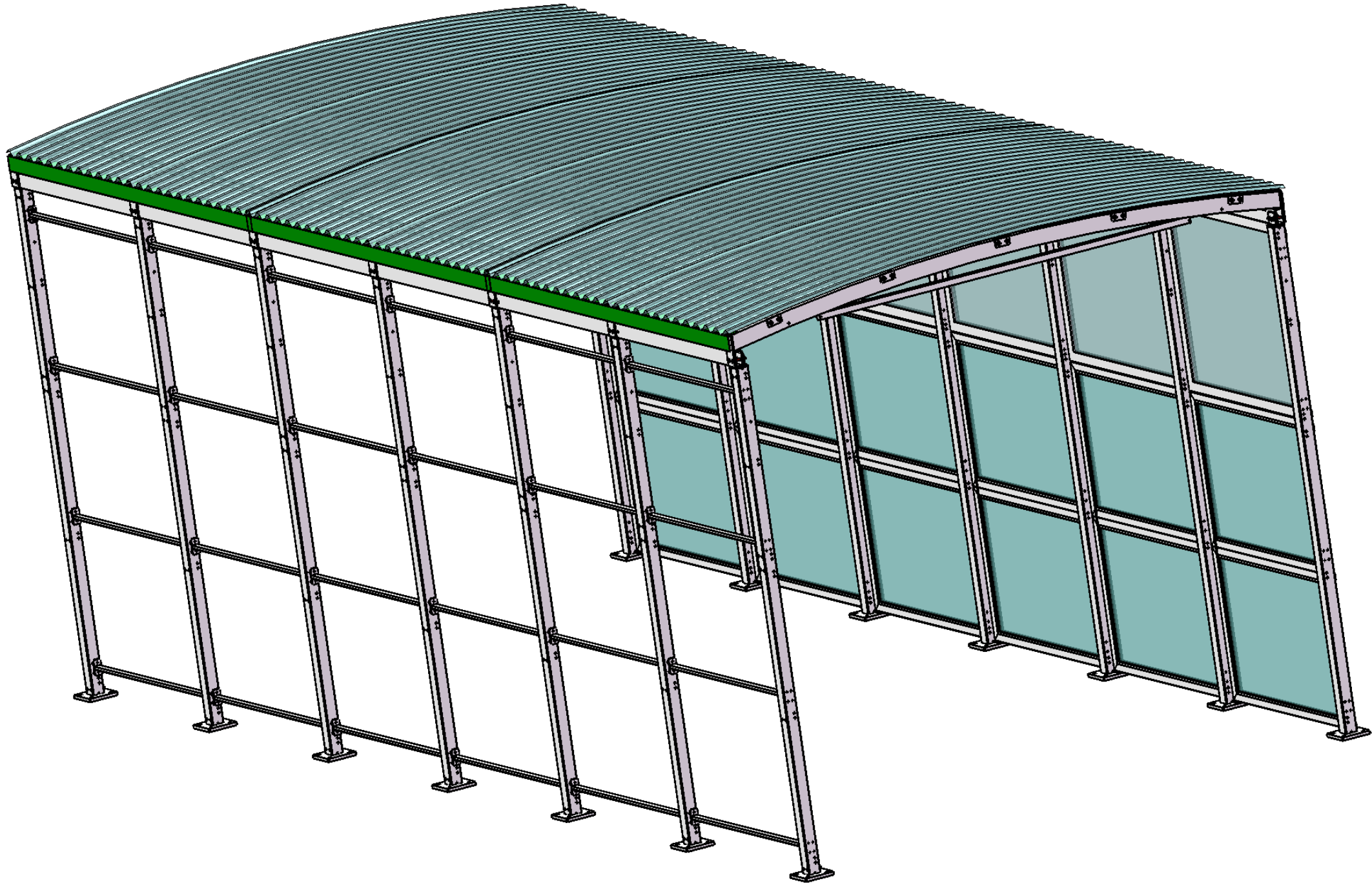

Wood plate installed

Put the 35X35X1420 wood lath on.
Like the picture show.
Connect with the self-tapping screws

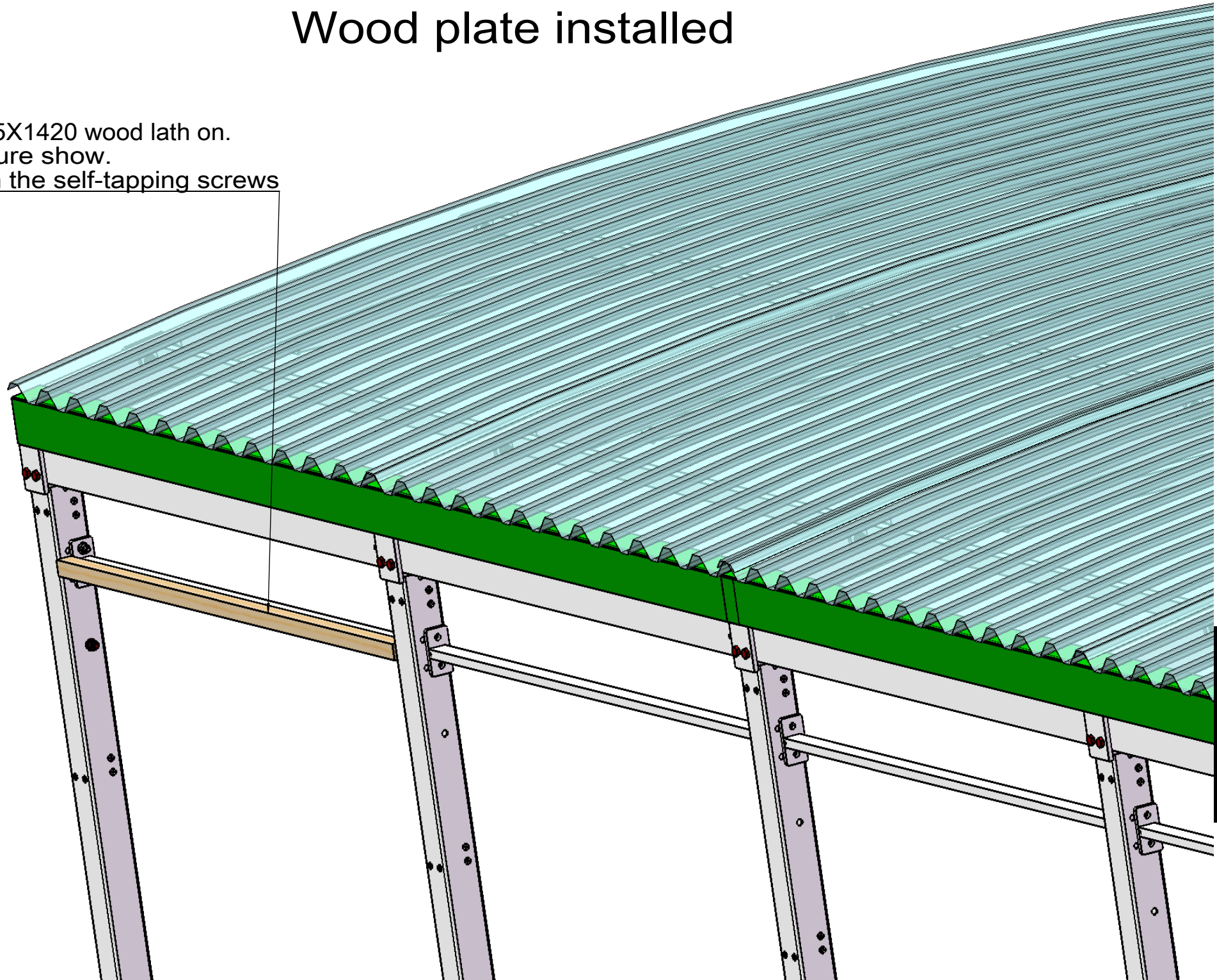

Wood plate installed

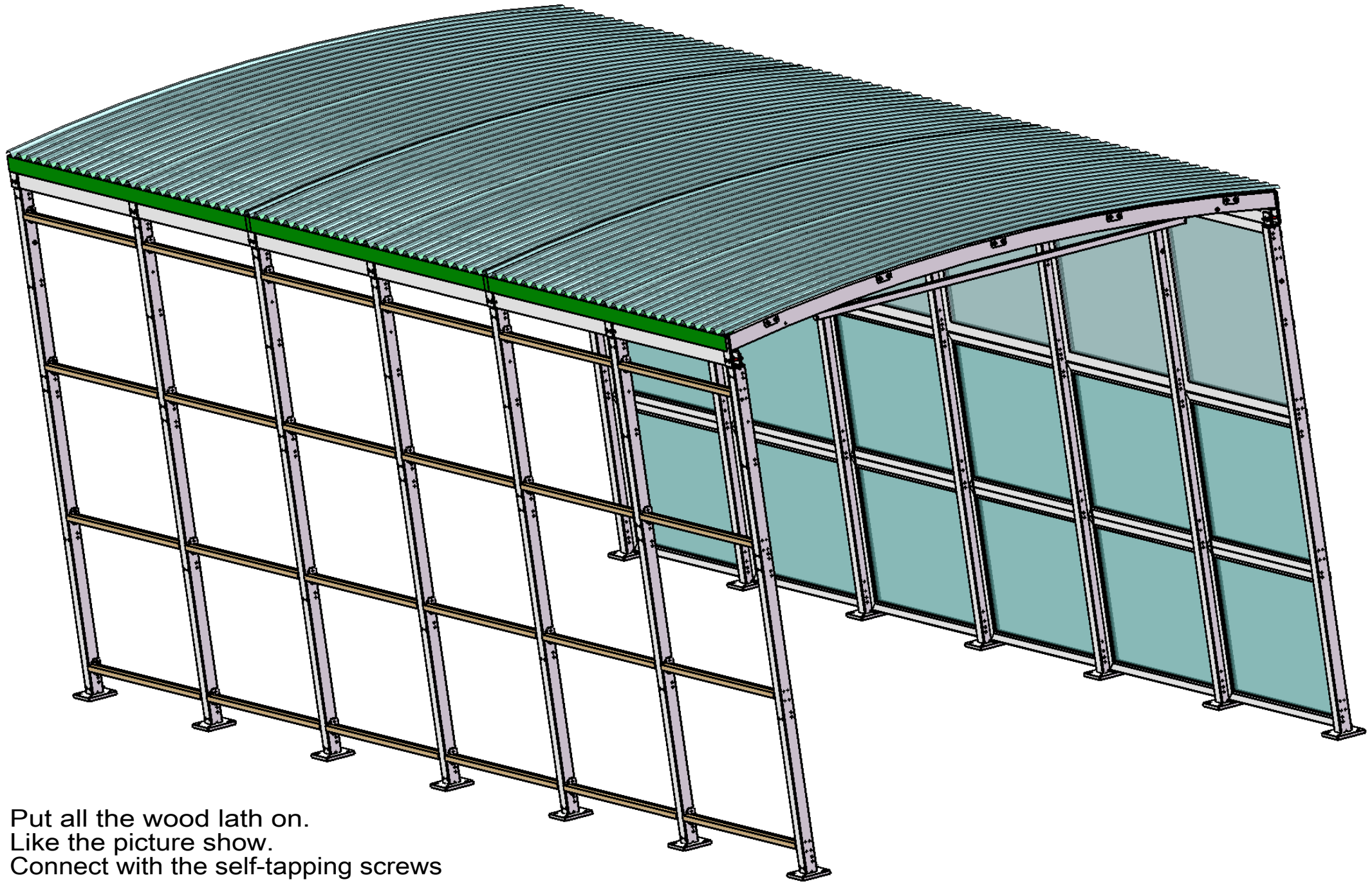

Put all the wood lath on.
Like the picture show.
Connect with the self-tapping screws

Wood plate installed

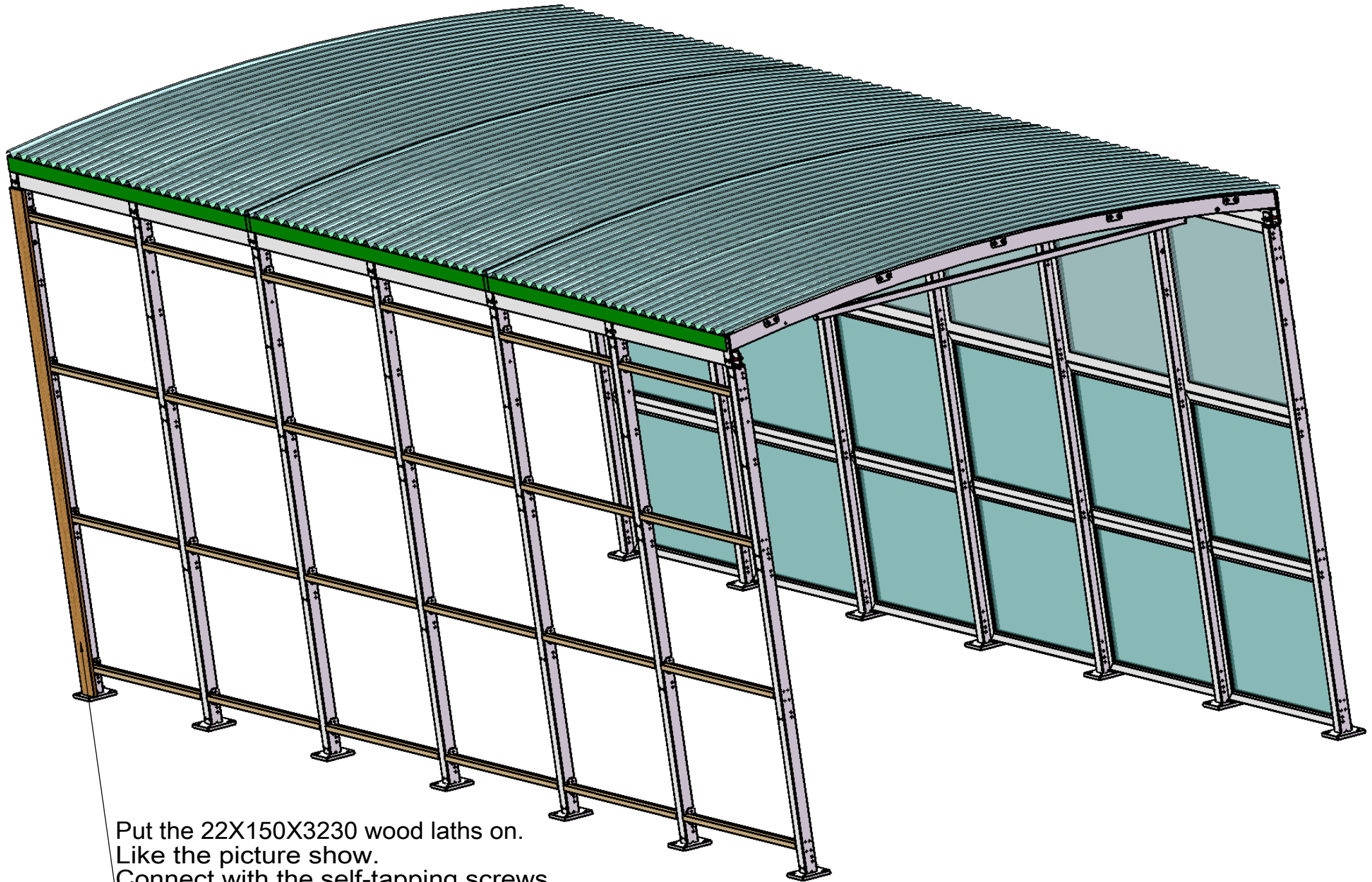

Put the 22X150X3230 wood laths on.
Like the picture show.
Connect with the self-tapping screws

Wood plate installed

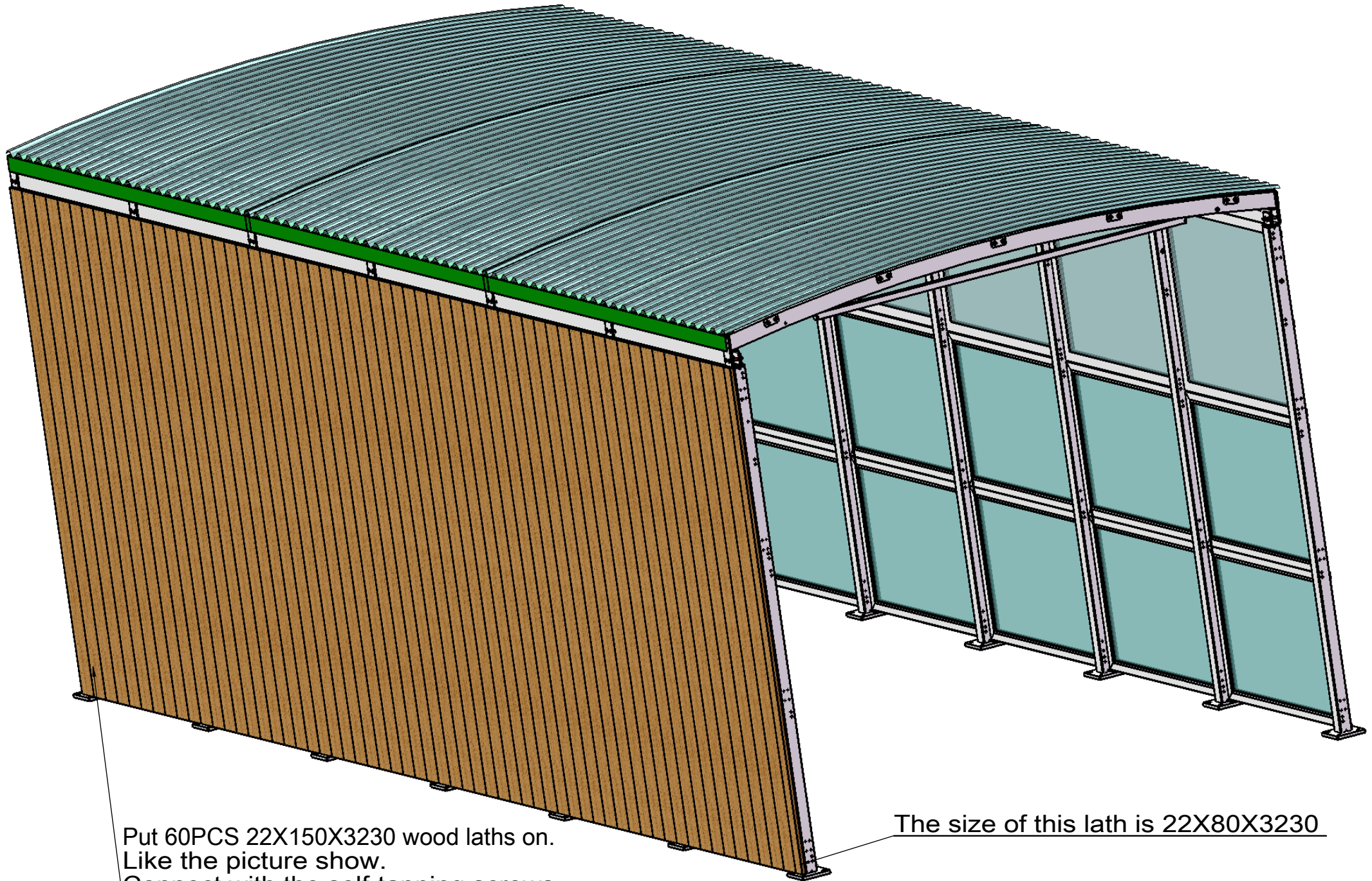

Put 60PCS 22X150X3230 wood laths on.
Like the picture show.
Connect with the self-tapping screws

The size of this lath is 22X80X3230

various installed ways

For this sample carport, you can install many different kind of carports. You can install one side window frame, two sides window frame, one side FRP plate, two sides FRP plate, one side wood plate, two sides wood plate, and also can install mixed ways.

After finished installed the two sides of the carport,we can install the inclined support
There are 2 inclined supports with one ring.

This side also has one inclined support with ring

inclined support with ring

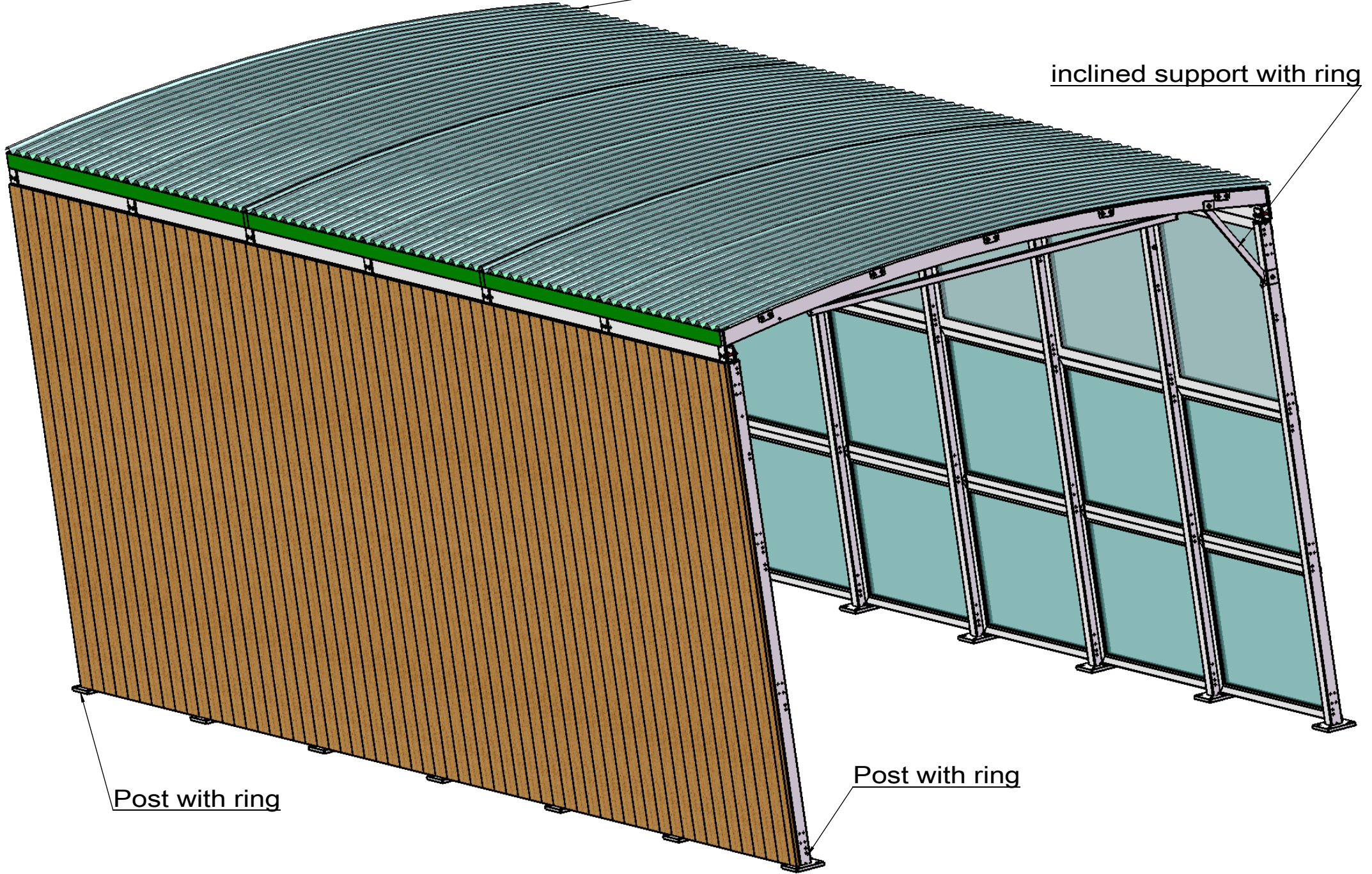

Post with ring

Post with ring

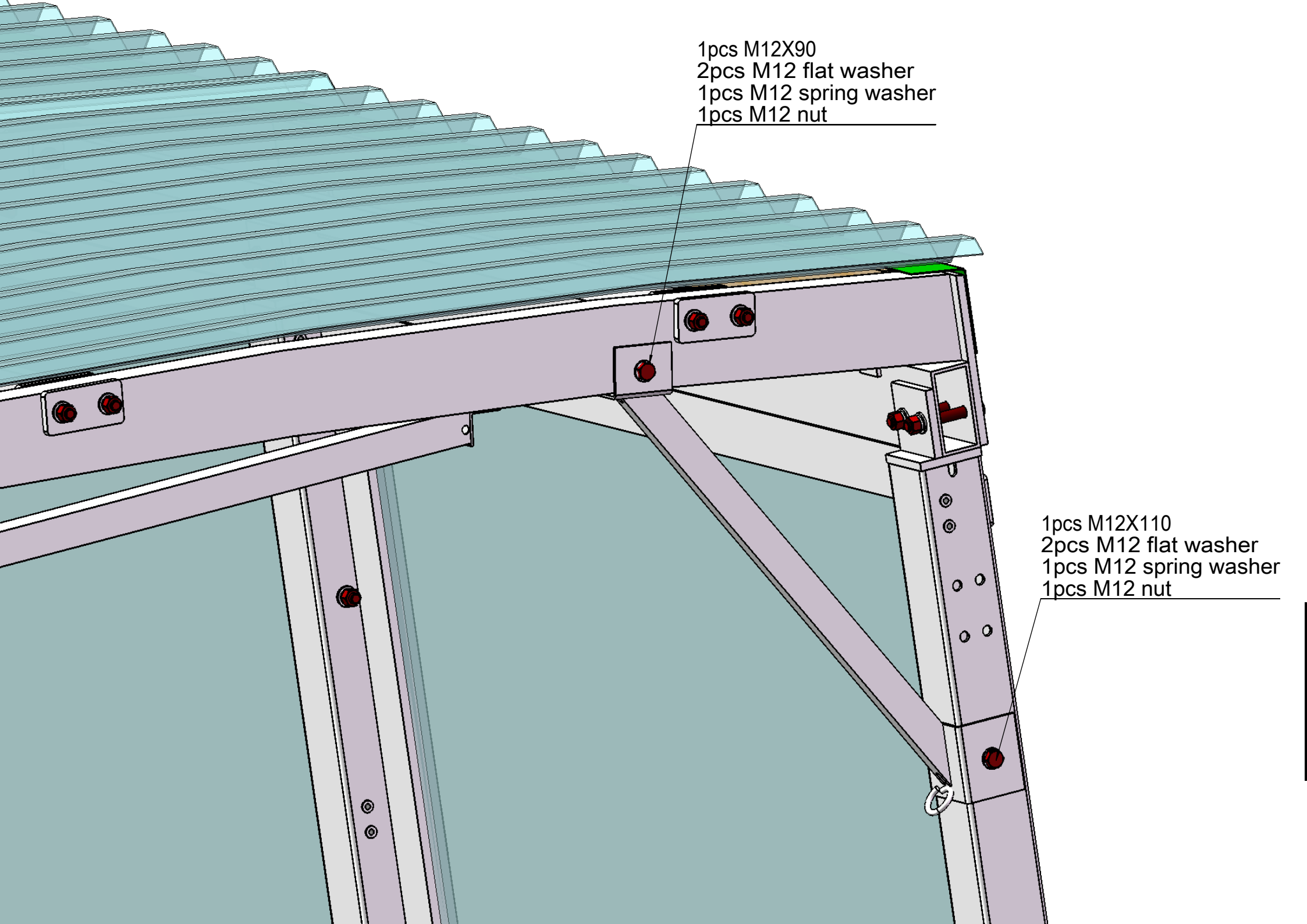

1pcs M12X90
2pcs M12 flat washer
1pcs M12 spring washer
1pcs M12 nut

1pcs M12X110
2pcs M12 flat washer
1pcs M12 spring washer
1pcs M12 nut

There are 12pcs inclined supports without ring.
Every post need install one inclined support

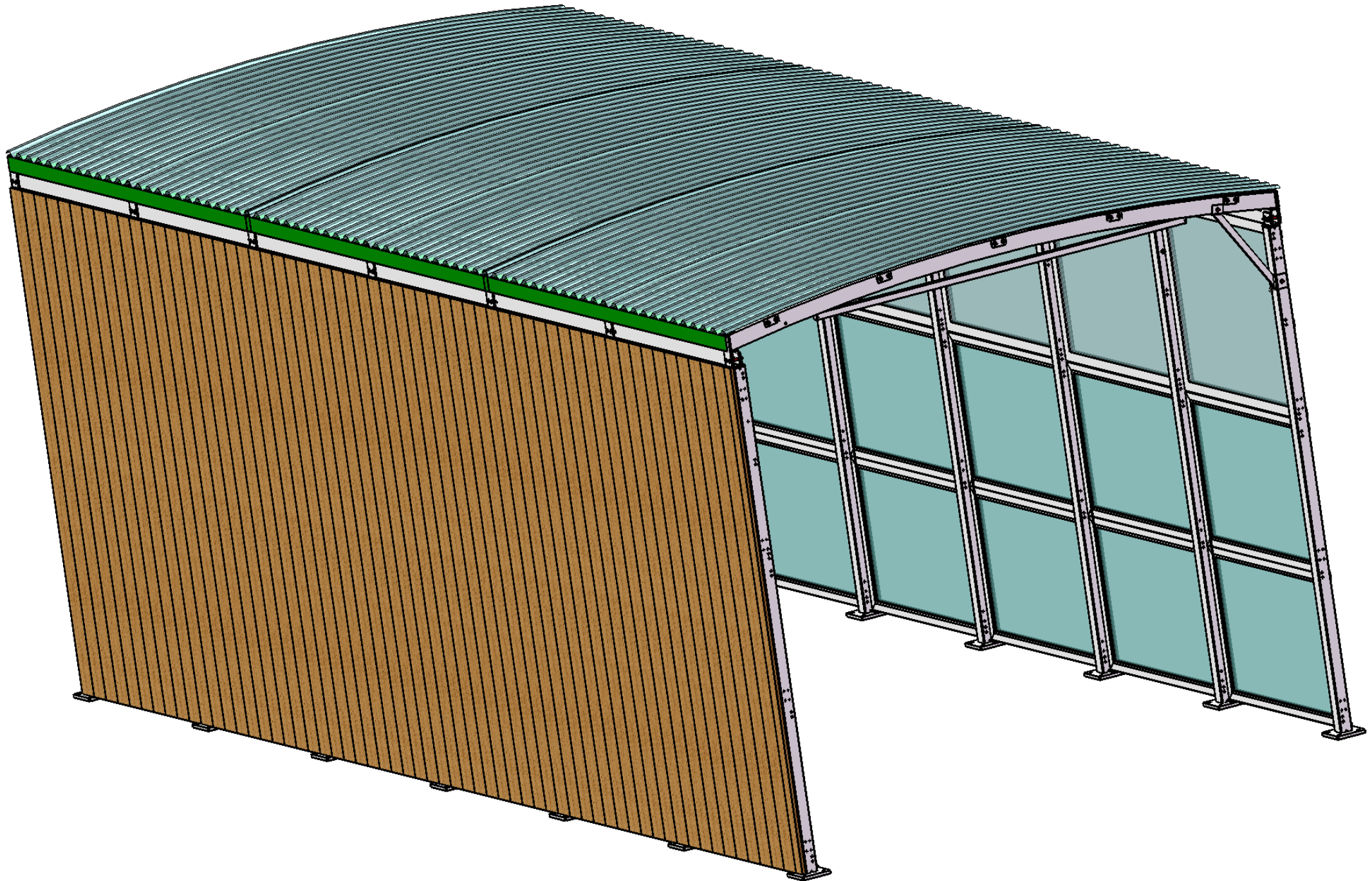

At last, we install the gutter system like the picture show

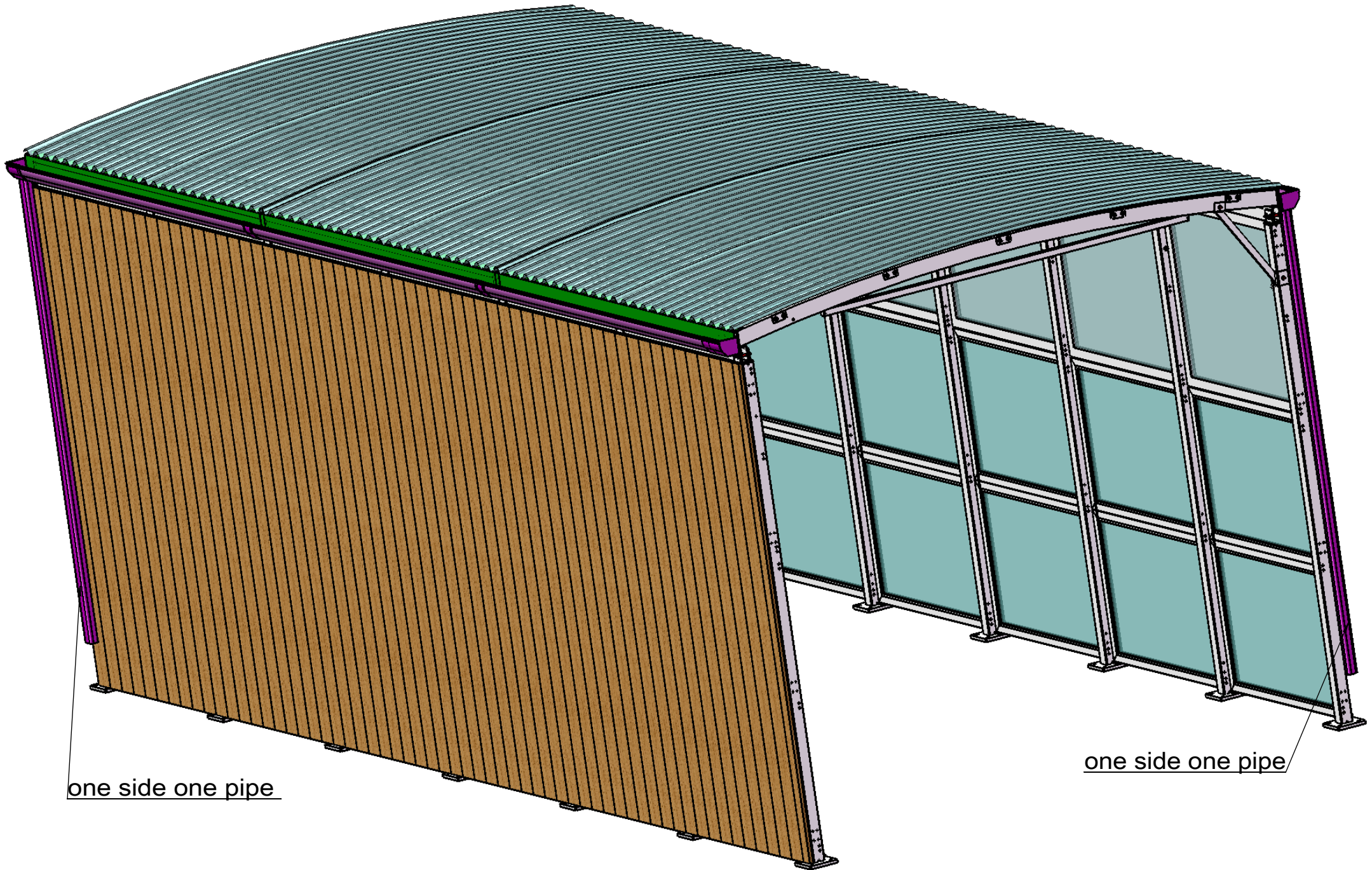

one side one pipe

one side one pipe